

**INMATEH -**

**AGRICULTURAL  
ENGINEERING**

**MAY - AUGUST**

## Editorial

The National Institute of Research Development for Machines and Installations designed to Agriculture and Food Industry - INMA Bucharest has the oldest and most prestigious research activity in the field of agricultural machinery and mechanizing technologies in Romania.

### Short History

- ✓ In 1927, the first research Center for Agricultural Machinery in Agricultural Research Institute of Romania - ICAR (Establishing Law was published in O.D. no. 97/05.05.1927) was established;
- ✓ In 1930, was founded The Testing Department of Agricultural Machinery and Tools by transforming Agricultural Research Centre of ICAR - that founded the science of methodologies and experimental techniques in the field (Decision no. 2000/1930 of ICAR, Manager - GHEORGHE IONESCU ȘIȘEȘTI);
- ✓ In 1952, was established the Research Institute for Mechanization and Electrification of Agriculture - ICMA Băneasa, by transforming the Department of Agricultural Machines and Tools Testing;
- ✓ In 1979, the Research Institute of Scientific and Technological Engineering for Agricultural Machinery and Tools - ICSITMVA was founded - subordinated to Ministry of Machine Building Industry - MICM, by unifying ICMA subordinated to MAA with ICPMA subordinated to MICM;
- ✓ In 1996 the National Institute of Research Development for Machines and Installations designed to Agriculture and Food Industry - INMA was founded - according to G.D. no. 1308/25.11.1996, by reorganizing ICSITMVA, G.D. no. 1308/1996 coordinated by the Ministry of Education and Research G.D. no. 823/2004;
- ✓ In 2008 INMA has been accredited to carry out research and developing activities financed from public funds under G.D. no. 551/2007, Decision of the National Authority for Scientific Research - ANCSno. 9634/2008.

As a result of widening the spectrum of communication, dissemination and implementation of scientific research results, in 2000 was founded the institute magazine, issued under the name of SCIENTIFIC PAPERS (INMATEH), ISSN 1583 - 1019.

Starting with volume 30, no. 1/2010, the magazine changed its name to INMATEH - Agricultural Engineering, appearing both in print format (ISSN 2068 - 4215), and online (ISSN online: 2068 - 2239). The magazine is bilingual, abstract being published in native language and English, with a rhythm of three issues / year: January-April, May-August, September-December and is recognized by CNCSIS - with B<sup>+</sup> category. Published articles are from the field of AGRICULTURAL ENGINEERING: technologies and technical equipment for agriculture and food industry, renewable energy, machinery testing, environment, transport in agriculture etc. and are evaluated by specialists inside the country and abroad, in mentioned domains.

Technical level and performance processes, technology and machinery for agriculture and food industry increasing, according to national requirements and European and international regulations, as well as exploitation of renewable resources in terms of efficiency, life, health and environment protection represent referential elements for the magazine "INMATEH - Agricultural Engineering".

We are thankful to all readers, publishers and assessors.

Editor in chief,

Ph. D. Eng. Vladut Nicolae-Valentin

**Managing Editorial Board - INMA Bucharest****Editor in Chief**

VLADUȚ Nicolae-Valentin

Ph.D.Eng, SR I

E-mail: [inmatehjournal@gmail.com](mailto:inmatehjournal@gmail.com)**Executive Editor**

POPA Lucreția

Ph.D.Eng, SR I

**Assistant Editor**

MATACHE Mihai-Gabriel

Ph.D.Eng, SR I

**Logistic support, database**

MURARU Virgil, Ph.D.Eng, SR I

ȚICU Tania, techn.

**Scientific Secretary**

Cârdei Petre, math.

**Official translators**

RADU Daniela-Cristina, English, French

**Editorial Board**

- Acad. Prof. Ph.D. TABĂRA Valeriu - Romania, President of ASAS - Academy of Agricultural and Forestry Sciences "Gheorghe Ionescu Șişești";
- Ph.D. BOGOESCU Marian - Romania, Vicepresident of ASAS - Academy of Agricultural and Forestry Sciences "Gheorghe Ionescu Șişești";
- Hon.Prof.Ph.D.Eng. PIRNĂ Ion - Romania, President of the Department of Agricultural Mechanization of ASAS - Academy of Agricultural and Forestry Sciences "Gheorghe Ionescu Șişești";
- Ph.D. Eng. NICOLESCU C. Mihai - Romania, Scientific General Secretary of the ASAS-Academy of Agricultural and Forestry Sciences "Gheorghe Ionescu Șişești";
- Assoc.Prof. Ph.D. Eng. BELC Nastașia - Romania, IBA Bucharest;
- Ph.D. Eng. BUȚU Alina - Romania, INSB Bucharest;
- Prof. Ph.D. Eng. PARASCHIV Gigel - Romania, P.U. Bucharest;
- Prof. Ph.D.Eng. BIRIȘ Sorin - Romania, P.U. Bucharest;
- Prof. Ph.D. Eng. VLASE Sorin - Romania, "Transilvania" University Brașov;
- Prof. Ph.D.Eng. BURNETE Nicolae - Romania, Technical University Cluj Napoca;
- Prof. Ph.D. Eng. FILIP Nicolae - Romania, Technical University Cluj Napoca;
- Prof. Ph.D. Eng. VOICU Gheorghe - Romania, P.U. Bucharest;
- Prof. Ph.D. Eng. GERGEN Iosif -Romania,USAMVB Timișoara;
- Prof. Ph.D. Eng. ȚENU Ioan - Romania, USAMV Iași;
- Assoc.Prof.Ph.D.Eng. BUNGESCU Sorin - Romania, USAMVB Timișoara;
- Prof. Ph.D.Eng. FENYVESI László - Hungary, Hungarian Institute of Agricultural Engineering Godolo;
- Assist.Prof.Ph.D.Eng. BILANDZIJA Nikola - Croatia, University of Zagreb;
- Ph.D. BIOCCA Marcello - Italy Agricultural Research Council, Agricultural Engineering Research Unit;
- Prof.Ph.D.Eng. MIHAILOV Nikolay - Bulgaria, University of Rousse;
- Assoc.Prof.Ph.D.Eng. ATANASOV At. - Bulgaria, University of Rousse;
- Assoc.Prof. Ph.D. ERTEKIN Can - Turkey, Akdeniz University Antalya;
- Prof. Ph.D.Sc. Eng. VARTUKAPTEINIS Kaspars - Latvia, Latvia University of Agriculture, Institute of Agricultural Machinery;
- ir. HUYGHEBAERT Bruno - Belgium, Walloon Agricultural Research Center CRA-W;
- Prof.Ph.D. Eng. FABBRO Dal Inacio Maria - Brazil, Campinas State University;
- Prof. PhD. Eng. DE WRACHIEN Daniele - Italy, State University of Milan;
- Prof. PhD.Guanxin YAO - P.R.China, Along Agriculture R&DTechnology and Management Consulting Co., Ltd;
- Prof. PhD. Eng. GONZÁLEZ Omar - Republic of Cuba, Central University "Marta Abreu" de las Villas;
- Assist. Prof.Dr. KABAŞ Önder -Turkey, Akdeniz University.
- Asist.Prof.Dr. SELVİ Kemal Çağatay - Turkey, Ondokuz Mayıs University.

In the present, **INMATEH - Agricultural Engineering** journal is indexed in the next international databases:  
 ELSEVIER /SciVerse SCOPUS, CLARIVATE ANALYTICS' WEB OF SCIENCE- Emerging Sources Citation Index (ESCI),  
 ULRICHS Web: Global Serials Directory, CABI, SCIPRO, Index COPERNICUS International,  
 EBSCO Publishing, Elektronische Zeitschriftenbibliothek

**INMATEH - Agricultural Engineering**

vol. 58, no.2 / 2019

NATIONAL INSTITUTE OF RESEARCH-DEVELOPMENT FOR MACHINES AND  
 INSTALLATIONS DESIGNED TO AGRICULTURE AND FOOD INDUSTRY -  
 INMA Bucharest

6 Ion Ionescu de la Brad Blvd., sector 1, Bucharest

Three issues per year,  
 e-ISSN: 2068 – 2239  
 p ISSN: 2068 – 4215

Edited by: INMA Bucharest

Copyright: INMA Bucharest / Romania

# CONTENT

	Page(s)
1.	9
<b>WORK PROCESS ANALYSIS OF THE MACHINES WITH WORKING PARTS ENTRAINED, IN SEEDBED PREPARATION WORKS /</b> <b>ANALIZA PROCESULUI DE LUCRU AL MAȘINILOR CU ORGANE DE LUCRU ANTRENATE, LA LUCRĂRILE DE PREGĂTIRE A PATULUI GERMINATIV</b> <b>Tolvally-Roșca F., Pásztor J.,</b> <sup>1)</sup> Sapientia Hungarian University of Transylvania, Faculty of Technical and Human Sciences, Târgu Mureș/ Romania DOI: 10.35633/INMATEH-58-01	
2.	17
<b>EFFECTIVE SIFTING OF FLAT SEEDS THROUGH SIEVE /</b> <b>ЭФФЕКТИВНОЕ ПРОСЕИВАНИЕ ПЛОСКИХ ЗЕРЕН НА РЕШЕТАХ</b> <b>Kharchenko S., <sup>1)</sup>, Kovalishin S., <sup>2)</sup>, Zavgorodniy A. <sup>1)</sup>, Kharchenko F. <sup>1)</sup>, Mikhaylov Y. <sup>3)</sup></b> <sup>1)</sup> Kharkiv Petro Vasylenko National Technical University of Agriculture; <sup>2)</sup> Lviv National Agrarian University; <sup>3)</sup> Tavria State Agrotechnological University DOI: 10.35633/INMATEH-58-02	
3.	27
<b>ELABORATION OF DOSING METHOD FOR LIQUID BIOFUEL COMPONENTS /</b> <b>ELABORAREA METODEI DE DOZARE A COMPONENTELOR BIOCOMBUSTIBILILOR LICHIZI</b> <b>Cerempei V. <sup>1)</sup>, Molotcov Iu. <sup>2)</sup></b> <sup>1)</sup> State Agrarian University of Moldova; <sup>2)</sup> Institute of Agricultural Technics "Mecagro" DOI: 10.35633/INMATEH-58-03	
4.	37
<b>WOOD DUST APPLICATION FOR IMPROVEMENT OF SELECTED PROPERTIES OF THERMOPLASTIC STARCH /</b> <b>WYKORZYSTANIE PYŁU DRZEWNEGO DO POPRAWY WYBRANYCH WŁAŚCIWOŚCI SKROBI TERMOPLASTYCZNEJ</b> <b>Żelaziński T. <sup>1)</sup>, Ekielski A. <sup>1)</sup>, Tułska E. <sup>1)</sup>, Vladut V. <sup>2)</sup>, Durczak K. <sup>3)</sup></b> <sup>1)</sup> Department of Production Management and Engineering, Warsaw University of Life Sciences– SGGW / Poland; <sup>2)</sup> National Institute of Research-Development for Machines and Installations Designed to Agriculture and Food Industry / Romania; <sup>3)</sup> Institute of Biosystems Engineering, Poznan University of Life Sciences / Poland DOI: 10.35633/INMATEH-58-04	
5.	45
<b>MODELING OF TRANSITION PROCESSES AND FUEL CONSUMPTION BY MACHINE-TRACTOR UNIT USING BIOFUEL /</b> <b>МОДЕЛЮВАННЯ ПЕРЕХІДНИХ ПРОЦЕСІВ ТА ВИТРАТ ПАЛИВА МАШИНО-ТРАКТОРНИМ АГРЕГАТОМ ПРИ ЗАСТОСУВАННІ ДИЗЕЛЬНОГО БІОПАЛИВА</b> <b>Golub G.A., Chuba V.V., Marus O.A.</b> National University of Life and Environmental Sciences of Ukraine, Kyiv / Ukraine DOI: 10.35633/INMATEH-58-05	
6.	57
<b>ANALYTICAL-EXPERIMENTAL STUDIES OF DELIVERY RATE AND VOLUMETRIC EFFICIENCY OF ROTOR-TYPE VACUUM PUMPS FOR MILKING MACHINE /</b> <b>АНАЛІТИЧНО-ЕКСПЕРИМЕНТАЛЬНІ ДОСЛІДЖЕННЯ КОЕФІЦІЄНТІВ ПОДАЧІ І ЗАПОВНЕННЯ РОТОРНИХ ВАКУУМНИХ НАСОСІВ ДЛЯ ДОЇЛЬНИХ УСТАНОВОК</b> <b>Dmytriv V.T. <sup>1)</sup>, Dmytriv I.V. <sup>1)</sup>, Borovets V.M. <sup>1)</sup>, Horodetskyi I.M. <sup>2)</sup>, Kachmar R.Y. <sup>1)</sup>, Dmyterko P.R. <sup>1)</sup></b> <sup>1)</sup> Lviv Polytechnic National University, Institute of Engineering Mechanics and Transport, Lviv / Ukraine <sup>2)</sup> Lviv National Agrarian University, Faculty of Mechanic and Power Engineering, Lviv-Dubliany / Ukraine DOI: 10.35633/INMATEH-58-06	
7.	63
<b>DYNAMIC SYSTEMS MODELING USING ARTIFICIAL NEURAL NETWORKS FOR AGRICULTURAL MACHINES / МОДЕЛИРОВАНИЕ ДИНАМИЧЕСКИХ СИСТЕМ С ИСПОЛЬЗОВАНИЕМ ИСКУССТВЕННОЙ НЕЙРОННОЙ СЕТИ ДЛЯ СЕЛЬСКОХОЗЯЙСТВЕННЫХ МАШИН</b> <b>Dorokhov A.S., Sibirev A.V., Aksenov A.G.</b> FSBSI "Federal Scientific Agronomic and Engineering Centre VIM"/ Russian DOI: 10.35633/INMATEH-58-07	
8.	75
<b>OPTIMIZATION RESEARCH ON THE COOLING OF LITHIUM BATTERY PACK FOR ELECTRIC MINI-TILLER / 电动微耕机电机组的散热优化研究</b> <b>Liang X.C., Huang S.</b> Southwest University, College of Engineering and Technology, Chongqing Key Laboratory of Agricultural Equipment for Hilly and Mountainous Regions / P. R. China DOI: 10.35633/INMATEH-58-08	

		Page(s)
9.	<p><b>KINEMATIC ANALYSIS AND EXPERIMENT OF CORN STRAW SPREADING PROCESS /</b>  <i>秸秆抛撒过程动力学分析与试验</i></p> <p>Liu Peng, Zhang Zhiqiang, He Jin<sup>1)</sup>, Li Hongwen, Wang Qingjie,            Lu Caiyun, Lou Shangyi, Liu Wenzheng, Cheng Xiupei            College of Engineering, China Agricultural University, Beijing/China            DOI: 10.35633/INMATEH-58-09</p>	83
10.	<p><b>DEVELOPMENT AND EVALUATION OF AN ENERGY AND WATER EFFICIENT INTENSIVE CROPPING SYSTEM /</b>  <i>توسعه و ارزیابی یک سامانه کشت متمرکز با بازده بالای آب و انرژی</i></p> <p>Seyed Iman Saedi<sup>1)</sup>, Reza Alimardani<sup>2)</sup>, Hossein Mousazadeh<sup>2)</sup>, Reza Salehi<sup>3)</sup>  <sup>1)</sup> Ph.D. candidate in Mechanical Engineering of Biosystems Department, University of Tehran, Karaj, Iran  <sup>2)</sup> Mechanical Engineering of Biosystems, University of Tehran, Karaj, Iran. <sup>3)</sup> Department of Horticultural Science, Faculty of Agricultural Science &amp; Engineering, University of Tehran, Karaj, Iran            DOI: 10.35633/INMATEH-58-10</p>	93
11.	<p><b>A DESIGN REUSE METHOD FOR AGRICULTURAL MACHINERY CAD MODEL WITH LIGHT PROPAGATION SIMULATION /</b>  <i>基于光传播模拟的农机装备 CAD 模型设计重用方法研究</i></p> <p>Honghao Liu<sup>1)</sup>, Kaixing Zhang<sup>1)</sup>, Xianxi Liu<sup>1)</sup>, Zhenghe Song<sup>2)</sup>  <sup>1)</sup> College of Mechanical and Electronic Engineering, ShanDong Agricultural University, China  <sup>2)</sup> College of Engineering, China Agricultural University, Beijing / China            DOI: 10.35633/INMATEH-58-11</p>	105
12.	<p><b>INFLUENCE OF THE MANURE SPREADING MACHINES' WORKING PARAMETERS ON THE QUALITATIVE PERFORMANCES OF THE FERTILIZATION PROCESS /</b>  <i>INFLUENȚA PARAMETRILOR REGIMULUI DE LUCRU AI MASINILOR DE FERTILIZAREA ORGANICA ASUPRA PERFORMANTELOR CALITATIV ALE PROCESULUI DE FERTILIZARE</i></p> <p>Ștefan V.<sup>1,2)</sup>, Cârdei P.<sup>1)</sup>, Popa L.<sup>1)</sup>, David L.<sup>2)</sup>, Ciupercă R.<sup>1)</sup>  <sup>1)</sup> National Institute of Research - Development for Machines and Installations Designed to Agriculture and Food Industry - INMA Bucharest / Romania; <sup>2)</sup> Politehnica University of Bucharest / Romania            DOI: 10.35633/INMATEH-58-12</p>	115
13.	<p><b>STATISTICAL MODELS FOR THE WORKING PROCESS CARRIED OUT BY THE SOLID ORGANIC FERTILIZER SPREADING MACHINE /</b>  <i>MODELE STATISTICE PENTRU PROCESUL DE LUCRU REALIZAT DE CĂTRE MAȘINA PENTRU ADMINISTRAT ÎNGRĂȘĂMINTE ORGANICE</i></p> <p>Cârdei P.<sup>1)</sup>, Ștefan V.<sup>1,2)</sup>, Popa L.<sup>1)</sup>, Ciupercă R.<sup>1)</sup>  <sup>1)</sup> National Institute of Research - Development for Machines and Installations Designed to Agriculture and Food Industry - INMA Bucharest; <sup>2)</sup> Politehnica University of Bucharest / Romania            DOI: 10.35633/INMATEH-58-13</p>	121
14.	<p><b>A NEW TECHNICAL SOLUTION OF A HEADER FOR SUNFLOWER HARVESTING</b>  <i>НОВЕ ТЕХНІЧНЕ РІШЕННЯ ЖАТКИ ДЛЯ ЗБИРАННЯ СОЛЯШНИКУ</i></p> <p>Nalobina O.O.<sup>1)</sup>, Vasylchuk N.V.<sup>2)</sup>, Bundza O.Z.<sup>1)</sup>, Holotiuik M.V.<sup>1)</sup>,            Veselovska N.R.<sup>3)</sup>, Zoshchuk N.V.<sup>1)</sup>  <sup>1)</sup>National University of Water and Environmental Engineering / Soborna str.11, Rivne, Ukraine;  <sup>2)</sup>Lutsk National Technical University / Lvivska str., 75, Lutsk, Ukraine;  <sup>3)</sup>Vinnitsia National Agrarian University / Soniachna str.,3, Vinnitsia, Ukraine            DOI: 10.35633/INMATEH-58-14</p>	129
15.	<p><b>ENGINEERING MANAGEMENT OF TWO-PHASE COULTER SYSTEMS OF SEEDING MACHINES FOR IMPLEMENTING PRECISION FARMING TECHNOLOGIES /</b>  <i>ІНЖЕНЕРНИЙ МЕНЕДЖМЕНТ ДВОФАЗНИХ СОШНИКОВИХ СИСТЕМ ПОСІВНИХ МАШИН ДЛЯ ТЕХНОЛОГІЙ ТОЧНОГО ЗЕМЛЕРОБСТВА</i></p> <p>Rogovskii I.L.<sup>1)</sup>, Titova L.L.<sup>1)</sup>, Trokhaniak V.L.<sup>1)</sup>, Rosamaha Yu.O.<sup>1)</sup>, Blesnyuk O.V.<sup>2)</sup>, Ohiienko A.V.<sup>3)</sup>  <sup>1)</sup> National University of Life and Environmental Sciences of Ukraine, Ukraine;  <sup>2)</sup> Kharkiv Petro Vasilenko National Technical University of Agriculture, Ukraine;  <sup>3)</sup> Mykolaiv V.O. Sukhomlynskiy National University, Ukraine            DOI: 10.35633/INMATEH-58-15</p>	137
16.	<p><b>IMAGE PROCESSING TECHNIQUES USED IN SOIL MOISTURE ANALYSIS /</b>  <i>TEHNICI DE PROCESARE A IMAGINII UTILIZATE ÎN ANALIZA UMIDITĂȚII SOLULUI</i></p> <p>Gheorghe C.<sup>1)</sup>, Deac T.A.<sup>1)</sup>, Filip N.<sup>1)</sup>  <sup>1)</sup> Technical University of Cluj - Napoca, Faculty of Automotive, Mechatronics and Mechanics / Romania            DOI: 10.35633/INMATEH-58-16</p>	147

## A NEW TECHNICAL SOLUTION OF A HEADER FOR SUNFLOWER HARVESTING

## НОВЕ ТЕХНІЧНЕ РІШЕННЯ ЖАТКИ ДЛЯ ЗБИРАННЯ СОНЯШНИКУ

Nalobina O.O.<sup>1)</sup>, Vasylychuk N.V.<sup>2)</sup>, Bundza O.Z.<sup>1)</sup>, Holotiuk M.V.<sup>1)</sup>, Veselovska N.R.<sup>3)</sup>, Zoshchuk N.V.<sup>1)</sup><sup>1)</sup>National University of Water and Environmental Engineering, Rivne / Ukraine;<sup>2)</sup>Lutsk National Technical University, Lutsk / Ukraine;<sup>3)</sup>Vinnitsia National Agrarian University, Vinnitsia / Ukraine

Tel: +380960825360; E-mail: o.z.bundza@nuwm.edu.ua

DOI: 10.35633/INMATEH-58-14

**Keywords:** sunflower, stem, header, harvesting, loss, technology, construction**ABSTRACT**

A number of the current research about the headers of the sunflower harvesting machine have been analysed and the main directions of their implementation are outlined. The design of the improved header is developed, which is designed to reduce the loss of seed and the height of the stubble on the field which remains after the completion of harvesting operations. The results of field research of developed and conducted construction are presented. Directions and fields of further research are outlined.

**РЕЗЮМЕ**

Проаналізовано ряд чинних досліджень жаток для збирання соняшнику та окреслено основні напрямки їхнього проведення. Представлено конструкцію удосконаленої жатки, яка розроблена з метою забезпечення зменшення втрат насіння та висоти товстостовбурової стерні на полі, яка залишається після виконання збиральних робіт. Викладено результати польових досліджень розробленої та виготовленої конструкції. Окреслено напрямки подальших досліджень.

**INTRODUCTION**

Sunflower is an annual plant, its name coming from the Greek 'helios anthos'. It is called a flower of the sun; it is one of the most productive crops. Interest in this culture is increasing due to high cultural adaptability to diverse agro climatic conditions and high quality oil (Martinez-Force E. et al., 2015).

The most powerful sunflower producers in the world today are Ukraine, Turkey, Bulgaria, Romania, Argentina, and Russia (Fig. 1).

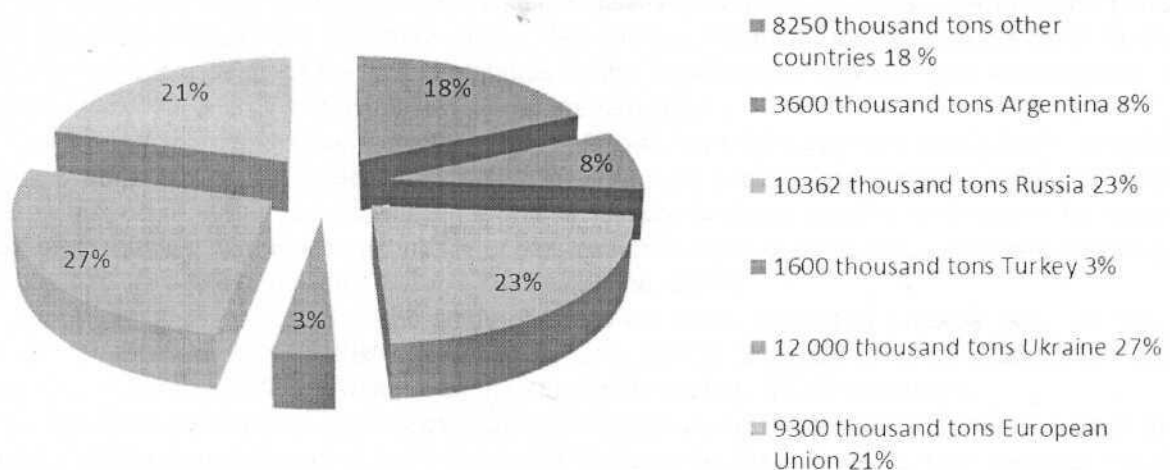

Fig. 1 - Diagram of sunflower seed production

<sup>1)</sup> Nalobina O.O., Prof. Ph.D. Eng.; Holotiuk M.V., Ph.D. Eng.; Bundza O.Z., Ph.D. Eng.; Zoshchuk N.V., Ph.D. Eng.; Vasylychuk N.V.; Veselovska N.R., Prof. Ph.D. Eng.

In Ukraine, in particular, over the past ten years the area under cultivation has grown by almost 60% (Fig. 2).

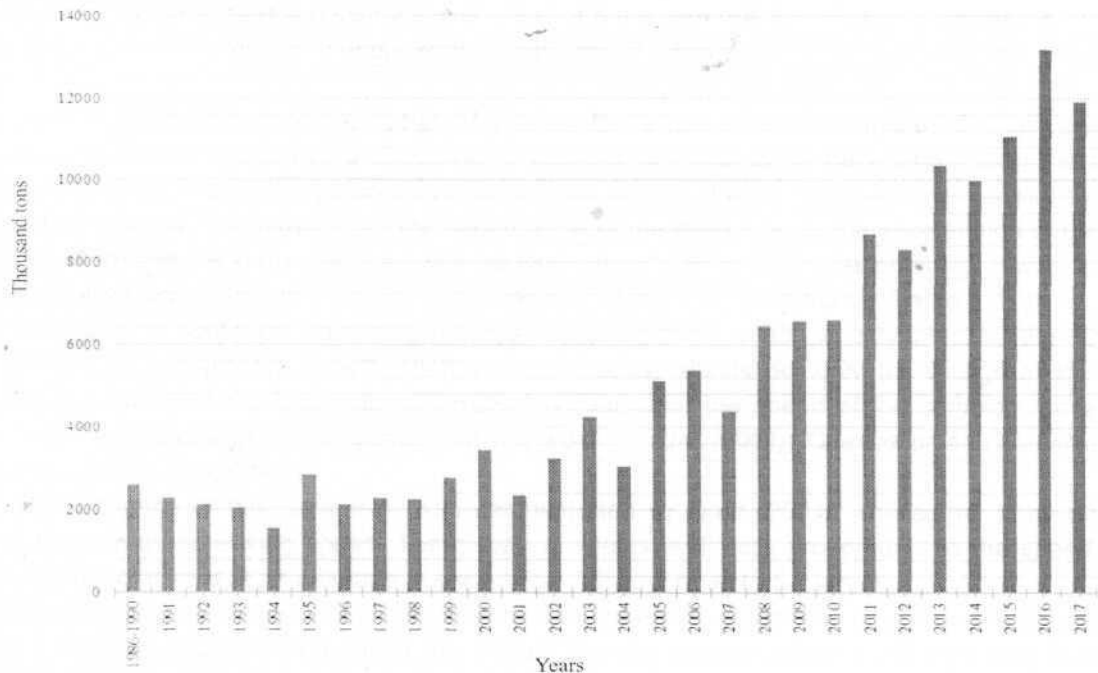

Fig. 2 - Dynamics of sunflower production in Ukraine

An important technological process for the cultivation of sunflower is harvesting. For the harvesting of sunflower grain harvesters with adaptations are used ('Sun Plant' PZN-9,4, PSP-1,5M, PS-4, PS-5, PS-6, PSP-10, PZS-8, KMS-8, CCD -12-45-01, etc.).

In order to ensure the high quality of the harvesting process, it is necessary to reduce the losses due to the peculiarities of the harvester structures, the falling of the calathidia with long stem remnants into the threshing apparatus that leads to the clogging of the deck, decreasing its passage section and, as a result, leads to seed traumatism (Skorik Dragan, 1992).

In addition, after harvesting there are relatively strong sunflower stems on the field, which complicate the preparation of the field until the next growing season (Fig. 3).

Vegetable sunflower wastes after harvesting require shredding and digging them in the soil for the purpose of their rapid decomposition and prevention of disease development. Thus, after-harvesting involves the use of additional equipment. For this purpose, disc harrows, toothed rotors, cutters are used. Additional damage to the upper layer of the soil contributes to the development of water and wind erosion. After harvesting, additional energy and human resources are required.

To eliminate this disadvantage, the technology of No-till farming has become widely used - a system of zero tillage, which is now gaining popularity in Ukraine. The main principle of the system is the use of natural processes that occur in the soil. Application of this technology to farms growing sunflower is hampered by reasons of operational nature such as the life of tires and caterpillars of agricultural machines is significantly reduced due to the rigors of rigid high stubble (Nalobina et al., 2018).

Popov (2012) is dedicated to the study of sunflower seeds harvesting process. Also Startsev and Popov (2011); Startsev (2017); Kukhmazov and Fedorov (2013), Shaforostov et al., (2007); Hunt (2001); Chancellor and Cervilka (1975); Nyborg et al., (2018); Nalobina et al., (2016) and others.

In the works by Startsev and Popov (2011); Kukhmazov and Fedorov (2013) the analysis of losses that appear during sunflower harvesting is described. In particular, the authors consider the influence of the working bodies' regime parameters on the loss of seeds. The analysis of all types of losses that appear during sunflower harvesting process is performed. Their classification by quantitative indicator is made.

A significant number of well-known researches are aimed at developing and improving working bodies for sunflower harvesting in order to reduce crop losses. In particular, in the work of Shaforostov et al., (2007) presents the results of studies by authors on the creation of a header for sunflower harvesting with screw conveyors for feeding the stems to the cutting unit. The authors developed screw feeding equipment with a variable step of winding. As a result of the field trials, it was established that the header, equipped with an

auger with an adjusted step, provides a reliable process, better stem selection, eliminates dynamic effects, which provides high qualitative parameters of the process.

*Popov (2012)* proposed a constructive solution of the screw-reel for sunflower harvesting. The author presented the results of theoretical analysis of a screw-motor design and the derivation of the equation of its rotation.

*Startsev (2017)* developed the design of a screw-feeder based on the concept of taking into account the physico-mechanical properties and geometric features of crops to be harvested during the design of harvesting machines. The author proposes to improve the design of an auger due to the installation of the G-shaped cut-off devices. The equation of the dependence of the seed loss on the acceleration of the collision of the calathidium and the sunflower stem with the working parts of the rope was obtained. It was established that losses decreased by 15% with reducing the diameter of the rotor shaft from 0.5 m to 0.32 m.

The quality of sunflower collecting process implementation, which is estimated by the size of the losses of the uncut calathidia, cut-off calathidia, and seeds, affects not only the design of the headers working bodies, but also the kinematic parameters, in particular the speed of the combine harvester with header. It is the analysis of this influence that the work of *Hunt (2001)*; *Chancellor and Cervinka (1975)*; *Nyborg et al., (2018)* is devoted to.

The importance of this parameter was demonstrated by *Hunt (2001)*. The author finds that overall losses increase with increasing speed. The growth of losses is directly proportional to the speed and can reach 4% of the total yield at an increase in speed from 3.2 km / h. up to 5.6 km / h.

*Chancellor and Cervinka (1975)* also investigated the effect of combine speed on the progress of the sunflower harvesting process. The author has proved that the rational speed is 3-5 mph, with lower values recommended for dry seeds (humidity of which is within 13-15%).

The performed analysis of current research has revealed that it can be divided into two directions as:

- research aimed at improving the design of the header to improve the quality of the harvesting process by reducing the damage to the seeds and their losses and shredding the remains of sunflower plants remaining in the field;
- research aimed at optimizing the kinematic parameters, in particular the speed of the harvesting combine.

Taking into account the above, we will formulate the purpose of the work: development of an improved design of a header for the harvesting of sunflower, which provides a reduction in seed losses and a decrease in the height of the long-winding stubble in the field, which remains after the completion of the harvesting operations.

To achieve this goal, the following tasks need to be solved:

- to make the design of the advanced header in accordance with the stated purpose;
- to make and investigate the physical model of the advanced header to prove its ability to work in the field.

## MATERIALS AND METHODS

The tasks were solved in several stages:

1. Development of the header design.
2. Making a physical model of the header.
3. Conducting field trials.

The development of an improved header design was carried out based on the principles of morphological analysis. To this end, a morphological table was formed (*Nalobina O., Markova O., Vasylichuk N., 2016*), the exclusion of variants from which was conducted under the following conditions:

1. Provision of planting sunflower seeds of any height.
2. Securing the cut of sunflower calathidia as close as possible to their base.
3. Avoiding clogging of the moving units with the remains of stems.
4. Reducing seed loss.

The choice of variants of the header constructive execution was carried out by successive exclusion of combinations of two and three variants. Results of the performed morphological analysis and synthesis of the technical object are reflected in the materials of the patent for the utility model "Sunflower harvesting knife" (*Vasylichuk and Nalobina, 2017*).

The basis of the proposed design is to create a sunflower header that will ensure the harvesting of a culture of any height, shredding the stems and reduce the clogging of the stubble unit moving knots (*Nalobina et al., 2018*).



In fig. 3, a schematic diagram of the sunflower harvesting kit design is provided.

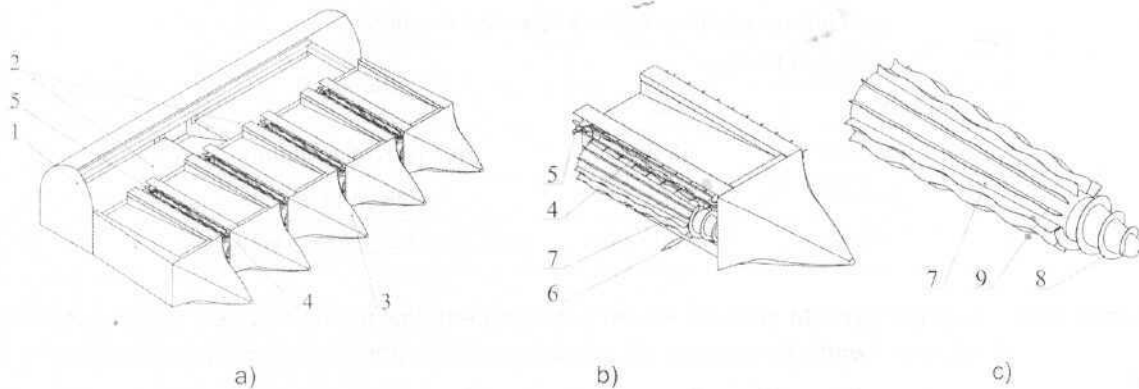

**Fig. 3 - Scheme of the header for sunflower harvesting**

*a – general view of the header; b – lift; c – the rotor*

The header consists of a frame 1, on which two belt conveyors 2 and lifters 3 are placed. Behind the lifters 3, passes with grips 4, are located cutters 5, for cutting the calathidia, cutting knives and shredding of stems, 6 and a tapered rotor 7, at the beginning of which there are screw turns 8, and then the surface of the rotor has sinusoidal ridges 9.

The sunflower harvesting kit works as follows: while the combine is used, the stems of the sunflowers are rejected by the lifters 3 and fall into the area of the passes with the ridges 4, that move the stems to the rotary knives 6 which cut the stems and to the knives 5 which cut the calathidia. At the same time, screw turns 8 and holds 9 on the rotor 7, capture the stems and move them down to rotating knives 6, where they are chopped into pieces. Due to the fact that the rotor 7 is conical, the capture of the lower stems does not occur immediately, while the higher stems fall under the action of seizures from the very beginning. This allows aligning the height of the stems with calathidia. After the calathidia are cut with knives 5, they hit the belt conveyors 2, which move them to the main part of the combine.

The proposed design of the header is intended for the harvesting of sunflower of any height, ensuring the cutting of calathidia as close as possible to their base, which will reduce the clogging of the header. It will additionally improve grinding of stems, which in turn eliminates the need for mulch application.

On the basis of the developed construction a physical model of the header was made. The header was aggregated with the CLAAS Lexion 570 combine. The equipment was installed on the Massey Ferguson 1006 sunflower header (Fig. 4).



**Fig. 4 - Improved header**

Before the research, measurements of the main indicators of sunflower plants (table 1) were made.

Table 1

**Characteristics of sunflower stems on the field**

Parameter	Years of research	
	2017	2018
Length of the stem, m	1.61±0.29	1.74±0.26
Plant height, m	1.47 ±0.34	1.69±0.38
Height of calathidia location, m	1.25 ±0.26	1.38±0.22

The harvesting was carried out with the upgraded header and the Massey Ferguson 1006 header. The list of parameters that were key subjects to change during the research is shown in table. 2.

Table 2

**Name of regulated parameters**

Name and units of measurement	Value
Speed of the combine, km / h	1.0 – 5.0
Duration of harvesting, days	2.0 – 16.0
Elevation position of elevators above the soil surface, m	0.5 – 0.75

The parameters were chosen based on a primary estimation of the regression relation between the following indicators:

- loss of seeds ( $\Delta_H$ ) – duration of carrying out the harvesting process ( $t$ );
- loss of seeds ( $\Delta_H$ ) – speed of combine ( $V_p$ );
- loss of seeds ( $\Delta_H$ ) – height of elevators over the surface of the soil ( $h$ ).

The dependencies describing the regression relationship and the corresponding correlation indices are given in table 3.

Table 3

**Results of parameters regression evaluation**

Regression equation	Randomization factor
$\Delta_H(t)=0.025t^2-0.2509t+2.33$	$R^2=0.916$
$\Delta_H(V_p)=0.144 V_p^2-0.3232 V_p+0.489$	$R^2=0.9849$
$\Delta_H(V_p)=41.005h - 40.543h + 12.253$	$R^2=0.9849$

A high randomization coefficient that is close to 1, indicates the reliability of the equations obtained.

Field tests were conducted to evaluate the work of the header proposed design and the definition of rational kinematic and structural parameters. Indicators were used to evaluate the work of the harvesters: seed loss, %; the length of the stem segment which comes with a calathidium for threshing.

On the basis of the experimental data obtained using the Mathcad program, regression equations were obtained that describe the effect of combine speed, duration of harvesting operations and height of lifters installation on the amount of seed loss:

For main header:

$$\Delta_H(t)=1.0253V_p+0.4651t+0.7052h-0.1089V_p \cdot t-0.5162V_p \cdot h-0.3092 \tag{1}$$

where  $h$  - height of installer, m.

For the proposed construction of the header:

$$\Delta_H(t) = 0.81891V_p + 0.4229t + 0.53h - 0.064V_p \cdot t - 0.23V_p \cdot h - 0.2071 \tag{2}$$

Surface of response is presented in fig. 5 and fig. 6.

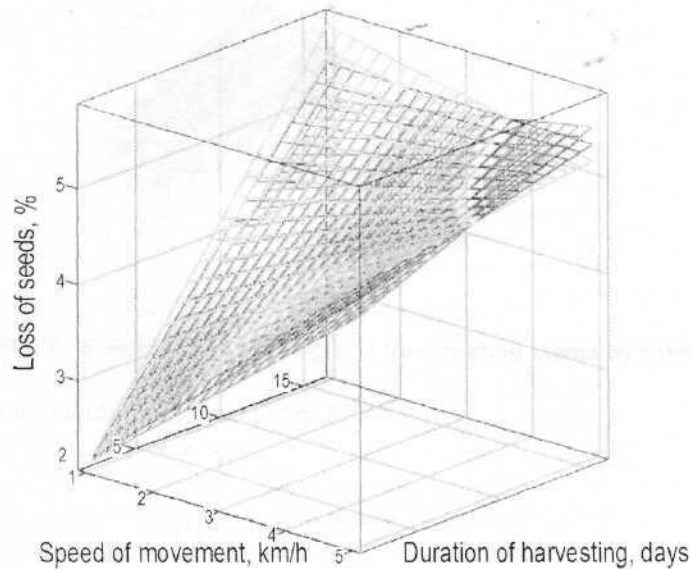

**Fig. 5 - Basic header (Massey Ferguson 1006)**

1 -  $h=0.55$  m; 2 -  $h=0.65$  m; 3 -  $h=0.75$  m

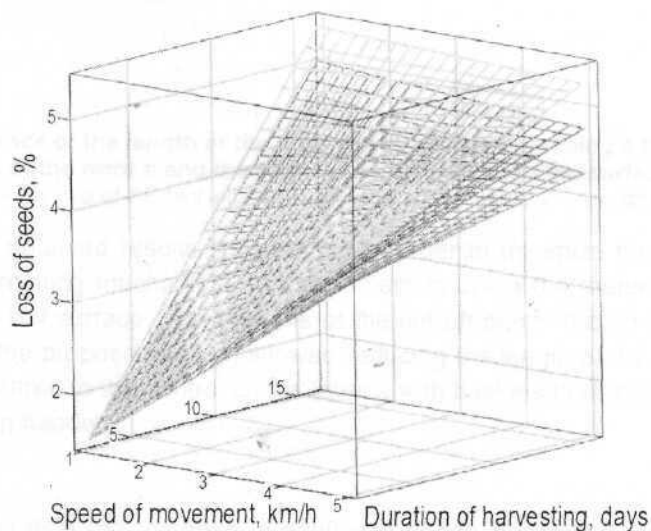

**Fig. 6 - Header of the proposed construction**

1 -  $h=0.55$  m; 2 -  $h=0.65$  m; 3 -  $h=0.75$  m

The most important factor that functionally characterizes the loss of seeds (figs. 5, 6) is the speed of the harvester. Taking into account the performed calculations (equations (1) and (2)) it is established that the lowest seed losses are provided under the following conditions:

- movement speed  $V_p=1.0...2.5$  km/h.;
- height of lifters  $h = 0.5...0.7$  m;

Terms of harvesting  $t \leq 5$  days.

On average, the use of an improved header allowed to reduce seed losses, by 1.4 times.

As mentioned above, to measure the work of the header it is needed to consider the length indicator of the stem segment, which comes with a basket for threshing.

The purpose of determining this indicator is to establish the rational parameters of the rotor 7 (fig. 1) length and angle of inclination to the surface of the soil.

The rotor was made with the length of 0.2 m and 0.4 m. The rotor was installed in two variants as 1 - the rotor axis was located parallel to the surface of the soil; 2 - axis of the rotor inclined along the direction of the combine's movement to an angle of 10 degrees (fig. 7). The speed of rotation was constant and it was  $300 \text{ min}^{-1}$ .

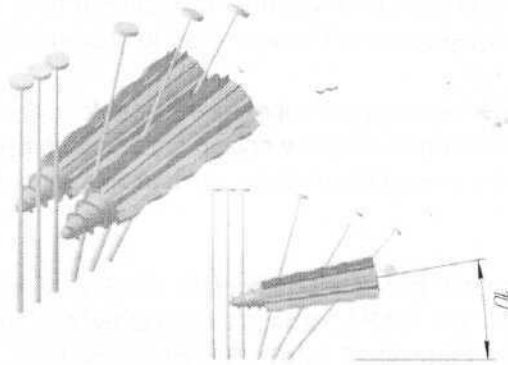

Fig. 7 - Scheme for capturing and transporting stems by rotor

The results of the research are shown in fig. 8.

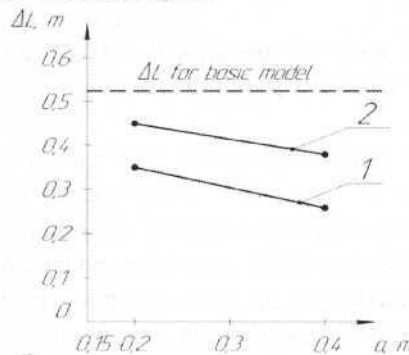

Fig. 8 - Dependence of the length of the stem  $\Delta L$  with basket reaching a threshing wheel on the length of the rotor  $a$  and the angle of its inclination to the surface of the soil

1 – the axis of the rotor inclined at an angle of 10 degrees; 2 – axis rotor

Comparison of the obtained results showed that in order to minimize the length of the stem of the calathidium entering the threshing mechanism, it is expedient to use a 0.4 meter long rotor and set it at an angle of 10 degrees to the soil surface. The analysis of the cut off plants that entered the range of the reel saw that the application of the proposed design allowed reducing the length of the stem with the calathidium, on average, by 31.6% compared to the control plants (stems with baskets that reached the reel area from the channels of the basic design header).

## RESULTS

Taking into consideration the increase in sunflower seeds harvesting in Ukraine and the need to address the application problems associated with ensuring the high quality of the harvesting process, it can be argued that scientific and experimental research aimed at finding technical solutions that will contribute to reducing losses of seeds, eliminating the problem of frequent hammering; reducing the height of the stubble. The proposed construction of a header for sunflower harvesting is promising in terms of solving the above mentioned problems. It has been established that during sunflower harvesting, a harvester must move along the field at the speed  $V_p = 1.0-2.5 \text{ km/h}$ ; lifters are installed at the height of  $h = 0.5-0.70 \text{ m}$ ; the terms of the harvesting work are  $t \leq 5$  days.

The rotor, equipped with an improved header, is 0.4 m long and is installed with an inclination of its axis to the soil surface at an angle of 10 degrees. The fulfilment of these conditions allowed to reduce the loss of seeds on average by 1.4 times and reduce the length of the stem with a calathidium on average by 31.6% compared with the control plants (stems with calathidia entering the reel area from the channels of the basic design header).

## CONCLUSIONS

Taking into account the increase in sunflower seeds sown in Ukraine and the need to address the application problems associated with ensuring the high quality of its harvesting process. It can be argued that scientific and experimental research aimed at searching technical solutions will contribute to reduce losses, eliminate the problem of frequent hammering, and reduce the height of the stubble.

The proposed construction of a header for sunflower harvesting is promising in terms of solving the above mentioned problems. As the results of field trials of the proposed design have been revealed, further research should be directed to:

- determination of the influence of proposed header design parameters on sunflower seeds loss;
- elimination of the revealed defect of the design which is in drive mechanism of the rotors (rotor drive, which is located in the front of the combine, contains an open cone gear).

## REFERENCES

- [1] Chancellor W.J., Cervinka V. (1975), Potential Harvesting Improvement with Optimum Combine Management. *Tras, World Applied Sciences Journal*, ASAE, Vol. 18(1). pp. 59-65, California / USA;
- [2] Dalmist I.S., Kayisoglu B., Bayhan Y., Ulger P., Toruk F., Durgut F., (2013), Development of a chopper unit for chopping of sunflower stalk during harvesting by combine harvester, *Bulgarian Journal of Agricultural Science*, Vol. 19, (no.5), pp. 1148-1154, Sofia / Bulgaria;
- [3] Hunt D. (2001), *Farm Power and Machinery Management. 10th Edition*. Iowa State University press, 376 p. ISBN-13: 978-1577665731, Iowa / USA;
- [4] Kukhmazov K.Z., Fedorov V.V. (2013), Reducing the loss of sunflower seeds when harvesting (Снижение потерь семян подсолнечника при уборке), *Niva Volga (Нива Поволжья)*, Vol.2, (No. 27), pp. 83-87, Ufa / Russia;
- [5] Martinez-Force E., Nurhan E., Joaquin T. J. (2015), *Sunflower: Chemistry, Production, Processing and Utilization*, Presented at Urbana, Illinois / USA;
- [6] Nalobina O., Markova O., Vasylichuk N., (2016), Application of morphological analysis and synthesis for the design of sunflower harvesting machines. WSEI scientific notebooks. Transport and IT series (Zastosowanie analizy i syntezy morfologicznej do projektowania maszyn do zbioru słonecznika. Zeszyty naukowe WSEI. Seria Transport i informatyka), Vol. 6 (1), *Lublin nnovatio Press Scientific Publisher of the University of Economics and Innovation (Lublin nnovatio Press Wydawnictwo Naukowe Wyższej Szkoły Ekonomii i Innowacji)*, pp. 45-52, Lublin / Poland;
- [7] Nalobina O.O., Gerasymchuk O.P., Puts V.S., Martyniuk V.L., Shovkomyd O.V., Vasylichuk N.V., Bundza O.Z., Holotyiuk M.V., Serilko D.L., (2018), Analytical investigation of the interaction of the sunflower stem with the lateral surface of the header lifter. *Inmateh Agricultural Engineering*, Vol. 55, No.2, pp. 171-180. ISSN 2068-4215, Bucharest / Romania;
- [8] Nyborg E.O. Nyborg E.O., Gregory R., (2018), Evaluation Report. URL: [http://pami.ca/pdfs/reports\\_research\\_updates/\(4c\)%20Grain%20Combines%20and%20Attachments/204.PDF](http://pami.ca/pdfs/reports_research_updates/(4c)%20Grain%20Combines%20and%20Attachments/204.PDF) (data of applying: 19.03.2018);
- [9] Popov M.Yu., (2012). Derivation of the equation of rotation of a screw cone with a straight cutter (Вывод уравнения вращения шнека-мотовила с прямым отсекателем), *Problems and perspectives of innovative development world agriculture (Проблемы и перспективы инновационного развития мирового сельского хозяйства)*, pp. 185-195, Saratov / Russia;
- [10] Skoric Dragan, (1992), The Potential of Sunflower Production in Sudan. *Arab Organization of Agricultural Development*. pp.14-30, Khartoum / Sudan;
- [11] Startsev A.S., (2017), Experimental-theoretical justification of the construction and diameter of the tube shaft of auger-reel scraper for harvesting sunflower (Экспериментально-теоретическое обоснование конструкции и диаметра трубного вала шнека-мотовила жатки для уборки подсолнечника), *Proceedings of the Orenburg State Agrarian University (Известия оренбургского государственного аграрного университета)*, Vol. 1, pp. 70–74, Orenburg / Russia;
- [12] Startsev A.S., Popov M. Yu., (2011), Investigation of the influence of a screw conveyor regime parameters on the loss of sunflower seeds in the process of mowing with a screw conveyor (Исследование влияния режимных параметров шнека-мотовила на потери семян подсолнечника в процессе скашивания шнеком-мотовилом), *Scientific Review (Научное обозрение)*, No. 6, pp. 131-136, Moscow / Russia;
- [13] Vasilchuk N.V., Nalobina O.O., (2017), *Sunflower harvesting knife (Жатка для збирання соняшнику)*. Patent No. 118144, Ukraine.