

University POLITEHNICA of Bucharest

SCIENTIFIC BULLETIN

Series D: Mechanical Engineering

Volume 71 Issue 1 2011

ISSN 1024-7604 (Print)
ISSN 1583-2281 (Online)

Being 100 years of independence (1918) anniversary issue of the Engineering and Technology Journal of the University POLITEHNICA of Bucharest, Volume 71, Issue 1, 2011, contains 100 articles, representing the activities of the faculty of the Faculty of Mechanical Engineering.

In the 100th anniversary issue of the Engineering and Technology Journal of the University POLITEHNICA of Bucharest, Volume 71, Issue 1, 2011, the authors have presented the results of their research and the scientific work of the Faculty of Mechanical Engineering, University POLITEHNICA of Bucharest.

The journal complies with the international rules (ISO 4) for the paper design for reproduction in a standard size of 210 mm x 297 mm (8.27 in x 11.7 in). The journal is published quarterly, in January, April, July and October. The journal is available online at www.scientificbulletin.upb.ro.

Copyright © 2011 by University POLITEHNICA of Bucharest, Faculty of Mechanical Engineering. All rights reserved. No part of this journal may be reproduced without the written permission of the publisher.

For further information please see:

ISSN 1024-7604

Engineering
Journal 1024

10
11

RESEARCH INTO OPERATING MODES OF THE AIR INJECTOR OF THE MILKING PARLOR FLUSHING SYSTEM

Iryna GUNKO ¹, Ihor BABYN ², Elchyn ALIIEV ³, Vitaliy YAROPUD ⁴,
Anatolij HRYTSUN ⁵

As a result of preliminary numerical simulation of the process of washing the milk line of the milking parlor using the injector in the software package STAR-CCM + was determined the dynamics of vacuum pressure at a distance from the injector and the dynamics of changes in the components of the multiphase environment. As a result of numerical modeling and experimental studies of the process of washing the milk line of the milking parlor using the injector, the dependence of the rate of pressure change, changes in the thickness of the milk layer on the milk pipe side and the degree of purity of the milk pipe at different values of its diameter from working vacuum pressure. air injector, also of the duration of the stroke of the inlet of the air injector and the duration of the pause of the air injector were determined.

Keywords: milking parlor, washing, air injector, modeling, experiment.

1. Introduction

The main task of dairy farming is to increase milk production and improve its quality. Among the indicators of quality as a raw material for further processing, its bacterial contamination is significant [1-2]. This indicator depends on the sanitary and hygienic condition of milking equipment, timely cooling of milk, requirements, and the impact of other external factors [3]. In the process of milking, milk passes through milking parlor, milk pipes, milk collectors, individual and group meters, etc., which are a source of bacterial contamination [4]. The recommended conditions for improving the quality of milk

¹ PhD, Associate Professor, Dept. of the department of general technical disciplines and labor protection, Vinnytsia National Agrarian University, Ukraine, e-mail: irynagunko@vsau.vin.ua

² Elder wkladach, Dept. of machinery and equipment for agricultural production of Vinnytsia National Agrarian University, Ukraine, e-mail: babyn@vsau.vin.ua

³ Doctor of Engineering Science, Senior Researcher, Prof., Dept. of mechanization of production processes in animal husbandry, Dnipro State Agrarian and Economic University, Ukraine, e-mail: aliev@meta.ua

⁴ PhD, Associate Professor, Dept. of the Department of machinery and equipment for agricultural production of Vinnytsia National Agrarian University, Ukraine, e-mail: yaropud77@gmail.com

⁵ PhD, Associate Professor, Dept. of the Department of Agro-engineering and Technical Service of Vinnytsia National Agrarian University, Ukraine, e-mail: gritsun@vsau.vin.ua

are to ensure the efficiency of the process of washing milking units by increasing its duration, which leads to increased operating costs (water, detergents, electricity, etc.) and the cost of dairy products [5].

Analysis of the factors and consequences of inefficient washing of milking parlors showed that the formation of contaminants (milk residues, rubbish, bacterial accumulations, other particles, and substances) on the inner surfaces of the milk system of the milking parlor are a result of poor technological operation of washing that leads to increase of bacterial contamination of milk and as a result to reduce its grade [6]. With insufficient cleaning and disinfection on the surface of the milk line of the milking parlor for a short period of time (20-40 min.) milk residues accumulate. They are a favorable environment for the development of microorganisms. Lactic acid bacteria in these environments, double the number of its average 40 min., *Escherichia coli* – 20 min. at 30 ° C [7]. In ideal conditions in the period between milking (9 hours at double milking) the number of microflora increases approximately in 17 thousand times. Bacteria remaining after disinfection in the amount of 2 % in the environment of lipid-protein contaminants can recover in about 3.5 hours. [8-9].

Changes in bacterial contamination of milk during its movement by the contaminated milk line of the milking parlor based on averaging data Degtyareva G. P. [10], Berezutsky V. I. [11], Kotelevich V. A. [12], Coj J. A. and Mamedova R. A. [13] showed an increase in bacterial contamination of milk as it progresses along the technological line: milking cups (8-16 thousand CFU/cm³), collector (34-47 thousand CFU/cm³), milk hose (74-85 thousand CFU/cm³), milk line (123-286 thousand CFU/cm³), milk collector (254-294 thousand CFU/cm³), milk pump (up to 320 thousand CFU/cm³).

Thus, the creation of automated technical and technological support of the washing system of milking parlor, which intensifies the process without additional costs, becomes of paramount importance in solving the problem of improving the quality of milk.

The purpose of the study is to increase the efficiency of the washing system of milking parlor by using air injectors with reasonable operating parameters of their work.

All types of milking parlor according to ISO 3918 [14], ISO 5707 [15], ISO 6690 [16] are a complex hydraulic network, which contains several types of hydraulic paths that differ in their parameters. These include milk pipelines, which move the flow of milk-air mixture; vacuum conductors with single-phase air flow; milk collectors, where, due to the significant amount of internal space, the flow rate approaches zero and there is a separation of liquid and gaseous phases (milk and air); milking parlor in which the pulsating mode of a current of both milk, and the air which is spent on creation of pulsations is carried out. According to the standard ISO 5707 [15], the design of the milking parlor should

also provide: cleaning of milk residues and deposits on the inner surface of the milk line; cleaning the surfaces and cavities of the milk line from the remnants of detergents and disinfectants; reduction of bacterial contamination of surfaces to an acceptable level. Milking unit communication units and parts in contact with the milk must be made of materials intended for this purpose. The surface, according to ISO 4288 [17], should have a roughness of 2.5 μm . The surface roughness of welds should not exceed 16 microns. Full drainage of fluid from all parts of the milk line should be ensured.

As a result of the analysis of technical and technological support of washing of milking parlors [18] it is established that the most effective are circulating systems of washing with regulated formation of a lock mode with using of air injectors on the basis of automatic control. This resource-saving mode is used by DeLaval in C100E washing machines, GEA Farm Technologies in SineTherm washing machine, etc. [19-20]. Also, air injection for efficient circulating washing of the milking parlor is used in MiniWash machines from PANAZOO and TOP WASH from InterPuls [21-22]. In particular, SAC offers flushing systems with spontaneous formation of liquid plugs and does not recommend the use of the Uni-Air-Pulse air pulsation device, believing that it does not affect the efficiency of washing milking equipment [23]. However, in the mode of cork flushing increases the additional air flow, which leads to an increase in the load on the vacuum pumps and because of increased energy consumption.

The analysis of theoretical and experimental preconditions [24-26] of technical and technological support of washing of milking parlors showed that the process of movement of two-phase washing solution at a lock mode which is formed under the effect of air injectors is not investigated enough for now.

The consequences of periodic operation of the injector are the phenomenon of hydraulic shock, which is caused by a sudden change in the phase distribution of the flow of two-phase washing solution. This leads to a sudden change in the impulse of the two-phase washing solution, causing a pressure wave moving through the system. This pressure wave can lead to the destruction of milk deposits on the walls of the milk line, as well as to possible damage to the equipment of the milk system [27-28]. The processes of damage and destruction under the influence of the shock wave depend on a large number of design features of the equipment (strength of the material, geometric dimensions, availability and quality of welds, soldering, joints, etc.) and the probability of their occurrence, so comprehensive studies of the above processes both from a theoretical point of view and from an experimental one are very hard to do. However, studies [29-30] indicate that the rate of pressure change $\Delta p/\Delta t$ to reduce the probability of appearing of hydraulic shock should be minimal.

Therefore, it is necessary to investigate in more detail the process of washing using air injectors and determine the relevant patterns on the basis of

which can be created an algorithm for washing the milk line of milking parlors with automated control of their operating parameters.

2. Materials and methods of research

The first stage of the study of the modes of operation of the air injector of the milking parlor is a numerical simulation of the movement of two-phase washing solution by a horizontal milk line using the software package STAR-CCM + [31]. The scheme of the numerical experiment is given in Fig. 1. The initial parameters for numerical simulation are as follows. The milk line of the milking parlor is a straight horizontal pipe with a diameter of $D_m = 50$ mm and a length of $L = 5$ m. On the left side of the chat, an injector with a diameter of $D_m = 10$ mm that is installed on top. The continuum grid of the milking line of the milking parlor was formed on the basis of a surface grid generator and a generator of polyhedral cells. The basic grid size was 0.001 m.

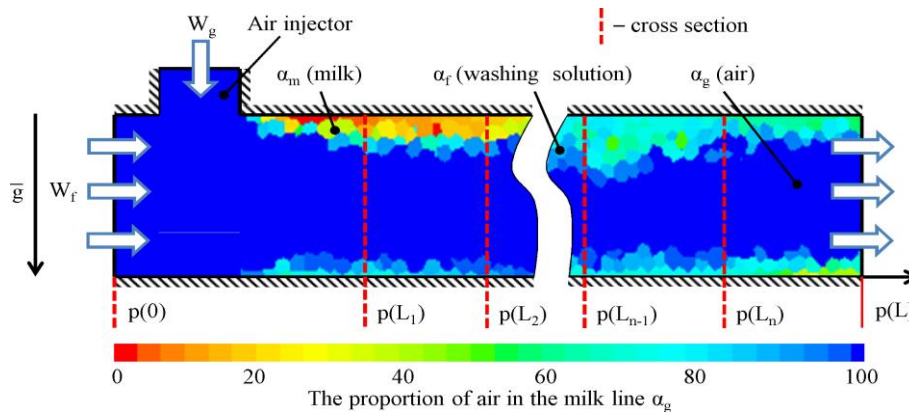

Fig. 1. Scheme of numerical experiment of the process of movement of a multiphase medium by a horizontal milk line of a milking parlor

Numerical simulations were performed on the basis of the following physical models: multiphase interaction, isothermal fluid energy equation, gravitational field, $k-\varepsilon$ turbulence model, Reynolds-averaged Navier-Stokes equation, separation flow, multiphase state equation, fluid volume (VOF), Euler multiphase [32]. As initial data, it was assumed that the washing solution in the process of movement had a constant density $\rho_f = 997.6$ kg/m³, the dynamic viscosity was $\mu_f = 8.88 \cdot 10^{-4}$ Pa·s. Milk also in the process of movement had a constant density $\rho_m = 1027$ kg/m³, its dynamic viscosity was $\mu_m = 2.72 \cdot 10^{-3}$ Pa·s. air was under the influence of the equation of an ideal gas. The dynamic viscosity of air was $\mu_g = 1.85 \cdot 10^{-5}$ Pa·s, molecular weight 28.9 kg/mol.

At the initial moment (initial conditions) it was assumed that the entire volume of the horizontal rectilinear milk line was filled with milk, ie $\alpha_m =$

100 %. The vacuum pressure was $p = 45$ kPa. Then on the left border was realized a mass air flow $W_g = 0.001$ kg/s, on the right – a constant vacuum pressure $p(L) = 45$ kPa, and the injector nozzle was completely closed (limit conditions). After 16 s (the time was selected from the condition of stabilizing the milk and air content in the volume of the milk line), the air flow stopped. Instead, a mass flow of washing solution $W_f = 0.2$ kg/s was realized on the left border. Studies have been conducted for options where the injector is periodically opened and closed. The open injector connects the internal volume of the milk line with atmospheric pressure and lets in air.

In the process of numerical simulation determined the dynamics of vacuum pressure in cross sections at a distance from the left boundary $p(0\text{ m})$, $p(1\text{ m})$, $p(2\text{ m})$, $p(3\text{ m})$, $p(4\text{ m})$, $p(5\text{ m})$ and the dynamics of the content of the components of the multiphase medium: washing solution α_f , air α_g , milk α_m .

The study factors were the diameter of the milk line D_m , the working vacuum pressure p_w , the duration of the intake stroke of the air injector t_{inj} , the duration of the pause of the air injector t_p . The limits and intervals of research factors are given in table. 1. A qualitative criterion for evaluating research on the modes of operation of the milk washing system of dairy milking equipment with an air injector is the average value of the thickness of the layer or drops of milk on the wall of the pipe h_m , which was determined by the formula

$$h_m = \frac{D_m}{2} \left(1 - \sqrt{1 - \frac{\alpha_m}{100}} \right) \tag{1}$$

Table 1

Limits and intervals of factors of numerical modeling and experimental researches

Level	Diameter milk wire D_m , mm	Working vacuum-metric pressure p_w , kPa	Duration of air intake stroke injector t_{inj} , s	Duration air injector pauses t_p , s	Volumetric air flow through the air injector Q_v , l/min
Top (+1)	70	75	9	9	100
Medium (0)	60	60	5	5	200
Lower (-1)	50	45	1	1	300
Interval	10	15	4	4	100

The smaller the value of the thickness of the layer of milk on the wall of the milk line h_m , the better the washing process was carried out.

The criterion that limits the operating parameters of the milk washing system of dairy milking parlor with an air injector is the value of the pressure change during the intake stroke and pause of the air injector (pressure change rate) $\Delta p/\Delta t$, which is calculated by the formula

$$\frac{\Delta p}{\Delta t} = \frac{p_{max} - p_{min}}{t_{inj} + t_p} \tag{2}$$

The greater the rate of change of pressure in the milk supply system of milking parlor, the greater the likelihood of "uncontrolled" water bump, which will destroy not only the layer of milk and milk deposits on the surface of its walls but can damage its equipment. Rational modes of operation of the milk washing system of milking parlor with an air injector can be achieved by minimizing the value of the thickness of the milk layer on the wall of the milk pipeline and the rate of pressure change.

The simulation was performed by alternately searching all levels of factors with a total of $3^4 = 81$ experiments. Next, using the Mathematica software package, a second-order regression model was determined for each of the proposed criteria.

The second stage is experimental research, which was conducted on an experimental stand on the basis of a laboratory milking parlor with existing upper and lower milk lines with a washing machine produced by TDV "Bratslav". The scheme of the experimental stand is given in Fig. 2.

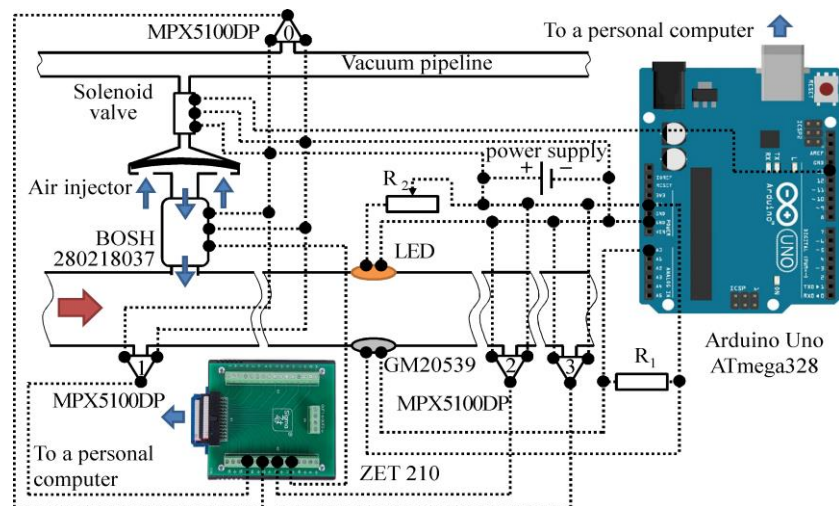

Fig. 2. The scheme of the experimental stand for research of operating modes of an air injector of system of washing of milk pipelines of milking parlor

The stand includes: laboratory milking unit (including milk line and vacuum line); air injector, solenoid valve; mass air flow sensor DMVP; four MPX5100DP vacuum gauge sensors, three of which are located on the milk line at a distance of 2 m from each other, and one – the vacuum wire that was connected to the ADC/DAC module ZET 210; photosensor for determining the contamination of the milk line, which consists of LED 1W 100 Lm, photoresistor GM20539, resistor $R_1 = 10 \text{ k}\Omega$, adjusting resistor $R_2 = 5 \text{ k}\Omega$, control board Arduino Uno ATmega328; power supply. A general view of the experimental stand is presented in Fig. 3.

Factors experimental research were working vacuum pressure p_w , length of stroke intake air injector t_{inj} , air injector pause duration t_p and the volume of air flow through the air injector Q_v . The limits and intervals of research factors are presented in table 1. The working vacuum pressure p_w is set on the laboratory milking unit using a vacuum regulator and is controlled by a vacuum pressure sensor MPX5100DP. The error of measuring the vacuum pressure within the investigated range is ± 0.1 kPa. The duration of the intake strokes t_{inj} and the pause t_p of the air injector was set using a solenoid valve, which is connected to the control board Arduino Uno ATmega328. The error of intake and pause cycles is ± 1 ms. Volumetric air flow through the air injector Q_v is set by closing the holes on the air injector and was controlled by the sensor of mass air flow DMVP BOSH 280218037.

Before each experiment, the photodetector was removed from the laboratory milking parlor, washed, wiped, and immersed in a container of milk for 20 minutes. Next, the research factors were set at the required level and the washing machine was started in the mode of continuous washing for 30 minutes.

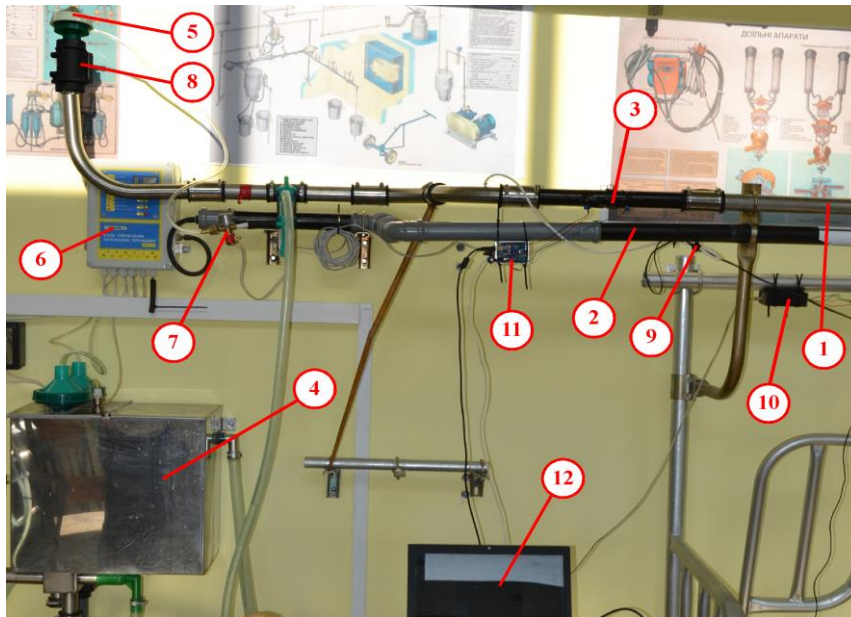

Fig. 3. The scheme of the experimental stand for research of operating modes of an air injector of system of washing of milk pipelines of milking installation:

- 1 – milk system; 2 – vacuum system; 3 – photodetector for determining the contamination of the milk line; 4 – tank with cleaning solution; 5 – air injector; 6 – automatic washing machine;
- 7 – solenoid valve; 8 – mass air flow sensor DMVP; 9 – vacuum gauge MPX5100DP;
- 10 – ADC/DAC module ZET 210; 11 – control board Arduino Uno ATmega328; 12 – personal computer

During the experimental studies, the dynamics of the vacuum pressure on each of the connected sensors was determined (p_0 , p_1 , p_2 , p_3). Qualitative

criterion for evaluating research on the modes of operation of the system of washing the milk lines of the milking parlor with an air injector is degree of purity θ_{milk} , which is defined as the change in the average value of the thickness of the layer of milk h_{milk} on the wall of the pipe:

$$\theta_{\text{milk}} = \frac{h''_{\text{milk}} - h'_{\text{milk}}}{h'_{\text{milk}}} \cdot 100 \quad (3)$$

where: h'_{milk} – the initial value of the thickness of the layer of milk on the wall of the pipe, mm; h''_{milk} – the final value of the thickness of the layer of milk on the wall of the pipe, mm

According to previous laboratory studies [33], the thickness of the layer of milk on the wall of the pipe was determined considering the value of resistance on the photodetector by the formula:

$$h_{\text{milk}} = \frac{1}{k_{\lambda\text{milk}}} \ln\left(\frac{R_f}{R_0}\right) \quad (4)$$

where: R_f – current value of resistance on the photodetector, Ohm; R_0 – initial value of resistance on the photodetector, Ohm; $k_{\lambda\text{milk}}$ is the rate of light absorption by milk, which was determined because of laboratory tests, mm^{-1} .

Experimental studies were performed according to the Hartley–Kono plan (Na-Co_4) for four factors at three levels with a total of 18 experiments. Next, using the Mathematica software package, a second-order regression model was determined for each of the proposed criteria.

3. Research results

As a result of numerical simulation, a graph of the dynamics of the content of components of the multiphase medium in the milk line of the milking parlor was constructed, which is given in Fig. 4. The first stage (from 0 to 16 s) is similar to the previous options. In the second stage, the supply of washing solution, which replaces air and milk was implemented. The injector is periodically opened and closed at intervals of 1 s (or another option 9 s) throughout the process. At 21.6 s (or another option 20.5 s) and further the value of milk content stabilizes and is $\alpha_m = 2.1\%$ (or another option 3.5 %). This indicates the residual milk on the walls of the milk line with an average layer thickness of 0.27 mm (or another option 0.43 mm). The dynamics of change of vacuum pressure is presented in Fig. 4. As can be seen from the figure, at each open of the injector, the milk line is connected to atmospheric pressure and the vacuum pressure in all areas first decreases to an average of -39.7 kPa (or another option -137.1 kPa), which is more than atmospheric, and then increases sharply to an average of 91.2 kPa (or another option 72.2 kPa). Then these fluctuations in vacuum pressure are repeated. The attenuation of the vacuum pressure for an interval of 9 s (up to 5 % of the average

value) occurs in 5.2 s. Analysis of fig. 4 allowed to draw a conclusion about the reduction of vacuum pressure at a distance from the injector. According to the above results, it can be argued that the use of a periodic injector allows you to reduce the milk content in the milk line faster and by a greater value, which indicates a better washing process.

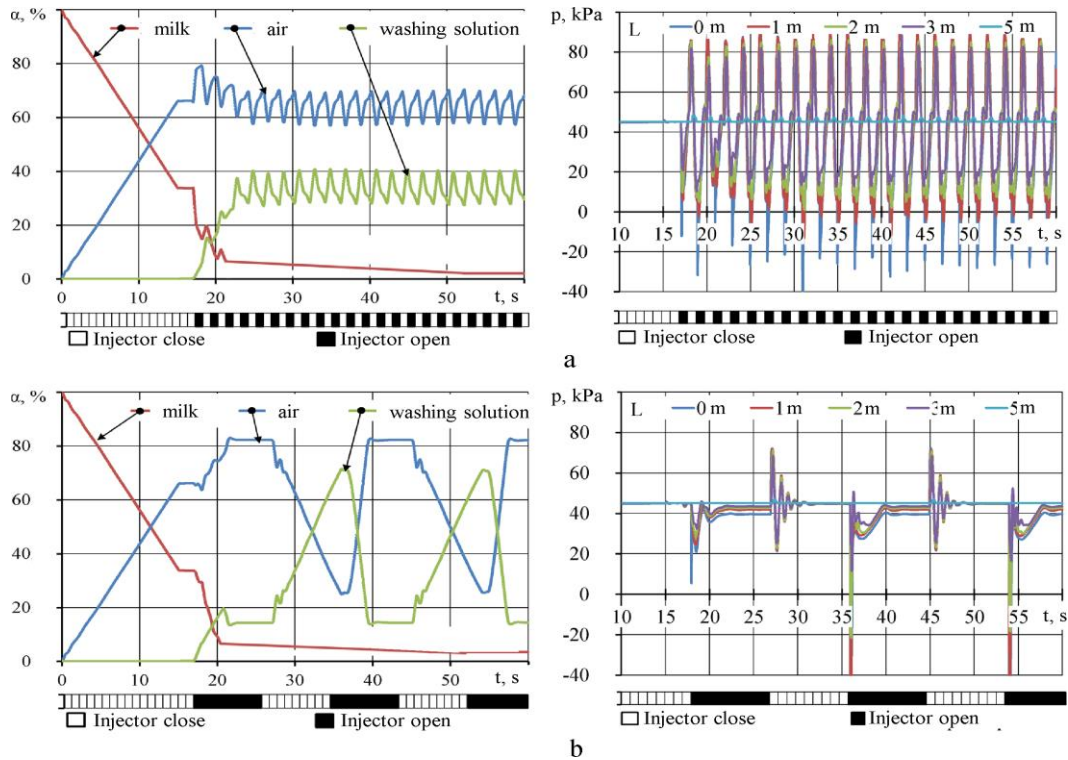

Fig. 4. Dynamics of changes in the content of components of the multiphase medium and the pressure in the milk line of the milking parlor for options when the injector is periodically opened and closed at intervals of 1 s (a) and 9 s (b)

As a result of numerical modeling and further processing of the received data in the Mathematica software package dependence of change of value of thickness of a layer of milk on research factors was obtained

$$\begin{aligned}
 h_{m(\text{teor})} = & 0.8738 - 0.03783D_m + 0.0006099D_m^2 + 0.01365p_w - 0.0004881D_m p_w + \\
 & + 0.0001357p_w^2 - 0.0228t_{\text{inj}} + 0.000114D_m t_{\text{inj}} + 0.002857t_{\text{inj}}^2 - 0.032454t_p + \\
 & + 0.0003051D_m t_p - 0.00114t_{\text{inj}} t_p + 0.00381 t_p^2. \quad (5)
 \end{aligned}$$

As a result of numerical simulation and further processing of the obtained data in the Mathematica software package, the dependence of the pressure changes during the inlet stroke and pause of the air injector (pressure change rate) on the research factors was obtained

$$\begin{aligned}
 \Delta p / \Delta t_{(\text{teor})} = & 37.6294 - 0.2269D_m + 1.7582p_w - 0.007633p_w^2 - 15.3799t_{\text{inj}} - \\
 & - 0.07374p_w t_{\text{inj}} + 1.01054t_{\text{inj}}^2 - 3.3746t_p - 0.04429p_w t_p + 0.9258t_{\text{inj}} t_p - 0.08726 t_p^2. \quad (6)
 \end{aligned}$$

As a result of experimental studies for each experiment, the dynamics of vacuum pressure on each of the connected sensors (p_0 , p_1 , p_2 , p_3) was obtained. We will explain the processes observed in the relevant graphs (Fig. 5). When opening the air injector (combining it with atmospheric pressure) there is a sharp drop in vacuum pressure to almost 0 kPa, which causes a negative hydraulic bump. Due to the constant operation of the vacuum pump and the presence of the receiver, the value of the vacuum pressure approaches the operating p_0 with certain damped oscillations was obtained. Then the air injector closes (disappears abruptly due to the combination of atmospheric pressure), which causes a sharp increase in vacuum pressure (almost twice) and, accordingly, a positive hydraulic bump. Due to the constant operation of the vacuum pump and the presence of the receiver, the value of the vacuum pressure is equalized to the operating p_0 by the function of the damping sine.

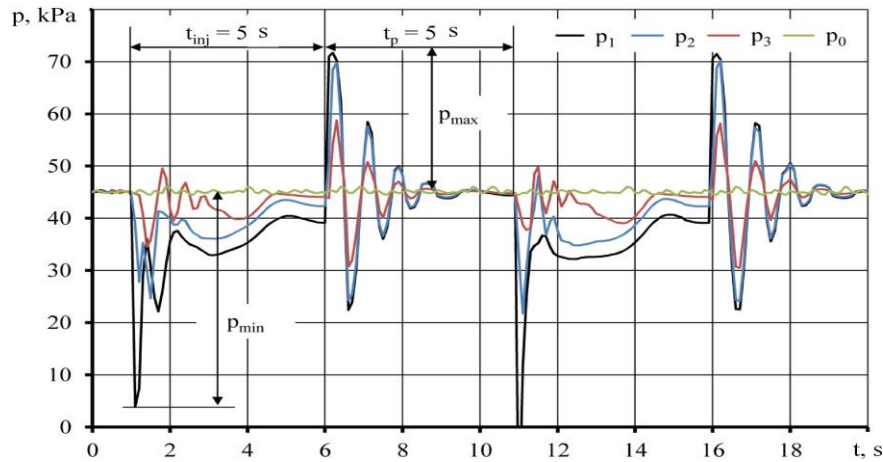

Fig. 5. Dynamics of vacuum pressure on the connected sensors (p_0 , p_1 , p_2 , p_3)

As a result of experimental research and the further processing of the received data in the Mathematica software package dependence of change of degree of purity θ_{milk} (%) on research factors was obtained

$$\begin{aligned} \theta_{\text{milk}(\text{teor})} = & 29.5872 + 1.4239p_w - 0.01554p_w^2 + 0.064Q_v - 0.00007181p_wQ_v + \\ & + 0.00011Q_v^2 - 0.12190t_{\text{inj}} - 0.00398p_w t_{\text{inj}} + 0.0002145Q_v t_{\text{inj}} - 0.08034t_{\text{inj}}^2 + \\ & + 1.6471t_p + 0.005675p_w t_p + 0.001481Q_v t_p + 0.1298t_{\text{inj}} t_p - 0.3895t_p^2. \end{aligned} \quad (7)$$

Recalculation of equation (5), obtained because of numerical simulation, by formula (3) allows determining the mathematical dependence of the change in the degree of purity θ_{milk} on research factors:

$$\begin{aligned} \theta_{\text{milk}(\text{exper})} = & 12.614 + 3.7837D_m - 0.0609942D_m^2 - 1.3656p_w + 0.04881D_m p_w - \\ & - 0.01357p_w^2 + 2.288t_{\text{inj}} - 0.01143D_m t_{\text{inj}} - 0.2857t_{\text{inj}}^2 + 3.2454t_p - \\ & - 0.030514D_m t_p + 0.114t_{\text{inj}} t_p - 0.3814t_p^2. \end{aligned} \quad (8)$$

Comparing the theoretical (8) and experimental (7) dependences visually (Fig. 6) and according to Fisher's criterion $F = 1.88 < F_{0.05}(17; 26) = 2.04$, Pearson's correlation coefficient $r = 0.98$ and coefficient of determination $R^2 = 0.96$, we can say about the adequacy of theoretical research.

As a result of experimental researches and the subsequent processing of the received data in the Mathematica software package dependence of change of pressure during time of an inlet stroke and a pause of an air injector (speed of change of pressure) on research factors was obtained

$$\Delta p / \Delta t_{(\text{exper})} = -9,2559 + 2,0453 p_w - 0,011788 p_w^2 + 0,145 Q_V - 12,0428 t_{\text{inj}} - 0,05044 p_w t_{\text{inj}} + 0,7961 t_{\text{inj}}^2 - 4,4597 t_p - 0,027 p_w t_p + 0,812 t_{\text{inj}} t_p. \quad (9)$$

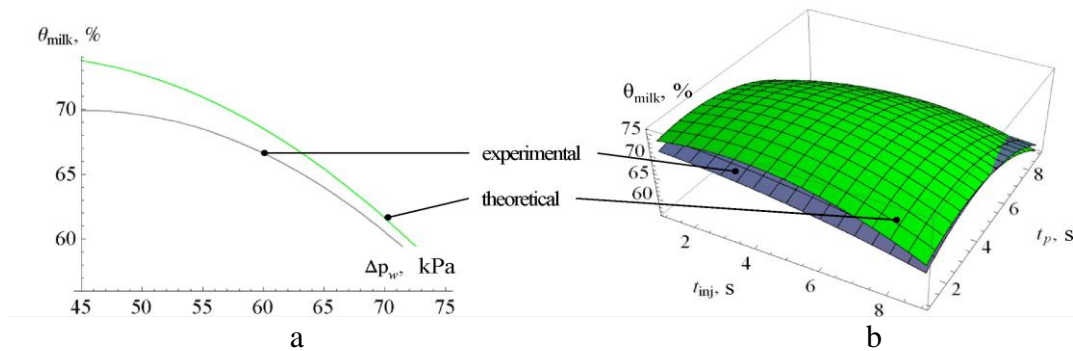

Fig. 6. Dependence of the degree of purity of the milk line θ_{milk} : a – on the working vacuum pressure p_w , b – on the duration of the intake stroke t_{inj} and the duration of the pause t_p air injector

Comparing the theoretical (6) and experimental (9) dependences visually (Fig. 7) and according to Fisher's criterion $F = 1.15 < F_{0.05}(17; 26) = 2.04$, Pearson's correlation coefficient $r = 0.99$ and the coefficient of determination $R^2 = 0.98$ can be said about the adequacy of theoretical research.

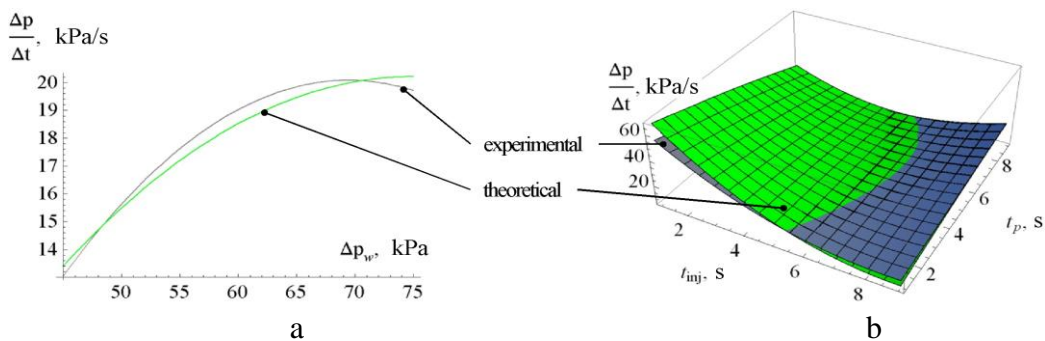

Fig. 6. The dependence of the rate of change of pressure $\Delta p / \Delta t$: a – on the working vacuum pressure p_w , b – on the duration of the intake stroke t_{inj} and the duration of the pause t_p air injector

Due to the fact that the rational parameters of the theoretical (7), (8) and experimental (6), (9) dependences are different, it is necessary to solve a

compromise problem, which is how to minimize the value of the rate of pressure change at the highest value of the purity of the milk pipeline:

$$\begin{cases} \theta_{\text{milk}}^{\text{teor.}}(D_m, p_w, t_{\text{inj}}, t_p) \rightarrow \max, \\ \theta_{\text{milk}}^{\text{exper.}}(p_w, t_{\text{inj}}, t_p, Q_v) \rightarrow \max, \\ (\Delta p / \Delta t)^{\text{teor.}}(D_m, p_w, t_{\text{inj}}, t_p) \rightarrow \min, \\ (\Delta p / \Delta t)^{\text{exper.}}(p_w, t_{\text{inj}}, t_p, Q_v) \rightarrow \min. \end{cases} \quad (10)$$

Solving the system of equations (10) in the Mathematica software package for different values of the diameter of the milk line we obtain the corresponding rational parameters of the injector modes: at $D = 50$ mm $\rightarrow p_w = 45.0$ kPa, $t_{\text{inj}} = 6.1$ s, $t_p = 3.8$ s, $Q_v = 300$ l/min, $\theta_{\text{milk}} = 92.3$ %, $\Delta p / \Delta t = 42.0$ kPa/s; at $D = 60$ mm $\rightarrow p_w = 45.0$ kPa, $t_{\text{inj}} = 6.1$ s, $t_p = 3.5$ s, $Q_v = 300$ l/min, $\theta_{\text{milk}} = 92.1$ %, $\Delta p / \Delta t = 42.1$ kPa/s; at $D = 70$ mm $\rightarrow p_w = 60.6$ kPa, $t_{\text{inj}} = 5.9$ s, $t_p = 3.4$ s, $Q_v = 300$ l/min, $\theta_{\text{milk}} = 88.4$ %, $\Delta p / \Delta t = 40.0$ kPa/s.

4. Conclusions

As a result of preliminary numerical simulation of the process of washing the milk line of the milking parlor using the injector in the software package STAR-CCM + was determined by the dynamics of vacuum pressure at a distance from the injector ($p(0$ m), $p(1$ m), $p(2$ m), $p(3$ m), $p(4$ m), $p(5$ m)) and the dynamics of changes in the content of the components of the multiphase medium (washing solution α_f , air α_g , milk α_m) for options when the injector periodically opens and closes. It is established that the use of a periodic injector allows reducing the milk content in the milk line faster and by a larger value, which indicates a better washing process.

As a result of numerical simulation process washing milk pipe line milking parlor using an injector in the software package STAR-CCM + was installed dependence of the rate of change of pressure $\Delta p / \Delta t$ and change the thickness of milk on the wall milk pipe h_m for different values of its diameter D_m of working vacuum pressure p_w , the duration of the stroke of the inlet of the air injector t_{inj} and the duration of the pause of the air injector t_p .

As a result of experimental studies modes of the air injector system of washing of milk milking parlor were installed depending on the rate of change of pressure $\Delta p / \Delta t$ and change the purity of milk θ_{milk} from the working vacuum pressure p_w , volumetric air flow through the air injector Q_v , cycle duration air injector inlet t_{inj} and air injector pause duration t_p .

Solving the compromise problem, which is to minimize the value of the rate of pressure change at the highest value of the degree of purity of the milk line

for different values of the diameter of the milk line obtained the appropriate rational parameters of the injector.

The results of research using in the development of designs automated washing systems milking line. The proposed method of using the phenomenon of water hammer in the system flushing as a means of intensifying the process of destruction of milk fat, increases the efficiency of washing milking line systems.

REFERENCES

- [1]. *I. A. Shevchenko, E. B. Aliiev*, Science and methodical recommendations for multicriteria production control of milking parlors, Zaporizhzhia: Accent Invest-trade, 2013, 156 p, ISBN 978-966-2602-41-VIII.
- [2]. *I. Shevchenko, E. Aliev*, Automated control systems for technical processes in dairy farming, Annals of Warsaw University of Sciences, SGGW, Agriculture (Agricultural and Forest Engineering), 2013, № 61, C. 41–49, ISSN 1898-6730.
- [3]. *V. V. Adamchuk, A. I. Fenenko, V. T. Dmitriv*, Mechanization and automation of milk production: monograph, Nezhin: Publisher PE Lysenko NM, 2013, 324 p.
- [4]. *A. P. Paliy*, Establishment of factors that influenc to the process of washing the milk parlor. Bulletin of the Poltava State Agrarian Academy, Poltava, 2015, № 1–2, pp. 80–83.
- [5]. *J. A. Coj, R. A. Mamedova*, The influence of parameters milk pipeline of milking installation on modes of motion an gas-liquid to mixtures. Problemy intensyfikacji produkcji zwierzecej z uwzględnieniem ochrony środowiska i standardów UE, Warszawa, 2005, pp. 355–359.
- [7]. *A. P. Paliy*, Research of process of washing of milking installations. Scientific Bulletin of Lviv National University of Veterinary Medicine and Biotechnology. S. Z. Gzhytsky, Lviv, Vol. 16, № 2 (59), Part 3, 2014, pp. 156–161.
- [8]. *O. Shkromada, O. Skliar, A. Paliy, L. Ulko, I. Gerun, O. Naumenko, K. Ishchenko, O. Kysterna, O. Musiienko, A. Paliy*, Development of measures to improve milk quality and safety during production // Eastern-European Journal of Enterprise Technologies, 2019, Vol. 3/11 (99), pp. 30–39, <https://doi.org/10.15587/1729-4061.2019.168762>.
- [9]. *A. Paliy, A. Naumenko, A. Paliy, S. Zolotaryova, A. Zolotarev, L. Tarasenko, O. Nechyporenko, L. Ulko, O. Kalashnyk, Y. Musiienko*, Identifying changes in the milking rubber of milking machines during testing and under industrial conditions // Eastern-European Journal of Enterprise Technologies, Vol. 5/1 (107), 2020, pp. 127–137, <https://doi.org/10.15587/1729-4061.2020.212772>.
- [10]. *G. P. Degterev*, Milk quality depending on the sanitary condition of milking equipment, Dairy industry, № 5, 2000, pp. 23–26.
- [11]. *V. I. Berezutsky*, Improving the technology of circulating washing of the milk line of the milking unit UDS-ZA, Dis. ... cand. tech. Science, Zernograd, 2000, 158 p.
- [12]. *V. A. Kotelevych, O. A. Zgozinska*, Veterinary and sanitary assessment of milk obtained from cows in the Experimental Farm "Gorodetske", Volodymyrets district, Rivne region, Scientific and Technical Bulletin of the Research Center for Biosafety and Environmental Control of Agricultural Resources, Vol. 2. № 3, 2014, pp. 106–110.
- [13]. *J. A. Coj, R. A. Mamedova*, Parameters of the cork regime of fluid flow in the milk line during washing, Engineering in Agriculture, M. Vol. 2, 2007, pp. 3–4.
- [14]. ISO 3918, Milking machine installations – Vocabulary, Geneva, Switzerland: The International for Standardization Organization, 2007, 42 p.
- [15]. ISO 5707, Milking machine installations – Construction and performance, Geneva, Switzerland: The International for Standardization Organization, 2007, 52 p.

- [16]. ISO 6690, Milking machine installations – Mechanical tests, Geneva, Switzerland: The International for Standardization Organization, 2007, 46 p.
- [17]. ISO 4288, Geometrical Product Specifications (GPS) – Surface texture: Profile method – Rules and procedures for the assessment of surface texture, Geneva, Switzerland: The International for Standardization Organization, 1996, 11 p.
- [18]. *M. Lutsenko, D. Zvoleyko*, Research of the process of milking cows in specialized milking parlors, *Technology and technologies of agro-industrial complex*, 2012, № 9 (36), pp. 31–34.
- [19]. Instructions for operation and installation of the SineTherm washing machine, Instructions of GEA Farm Technologies, 2010, 210 p.
- [20]. De Laval system book: Automatic washing machine C100E, 2003, 95 p.
- [21]. E.M.W. Washing Machine Operation Manual, PANAZoo Manual, 2005, 25 p.
- [22]. Instruction on operation of the TOP WASH washing machine, Instruction of the InterPuls firm, 2008, 22 p.
- [23]. UNIWASH2 Washing Machine Installation and Maintenance Manual, SAC Manual, 2003, 90 p.
- [24]. *A. P. Paliy*, Substantiation, development and efficiency of application of innovative technologies and technical decisions in dairy cattle-breeding: Dis...Dr. s-g. Sciences, Mykolaiv, 2018, 382 p.
- [25]. *D. J. Reinemann*, System Design and Performance Testing for Cleaning Milking Systems. Proc. Designing a Modern Milking Center, Northeast Regional Agricultural Engineering Services National Conference, Rochester New York, 1995, Nov. 29, dec. I.
- [26]. *V. Dmytriv*, Dynamic characteristics of hydropneumatic milking systems. Zbornik radova: proceedings, Opatija, Croatia. February 13–16, 2007, pp. 332-335.
- [27]. *Okoye Obuora A.*, Evaluation Of Two Phase Flow Characteristics In A Pipeline: Homogenous Model Approach, *International Journal of Scientific & Technology Research*, Issue 7, 2016, pp. 319–326.
- [28]. *Boran Zhang, Wuyi Wan, Mengshan Shi*, Experimental and Numerical Simulation of Water Hammer in Gravitational Pipe Flow with Continuous Air Entrainment, *Water*, 10 (7), 2018, pp. 928. <https://doi.org/10.3390/w10070928>.
- [29]. *E. B. Aliiev*, Estimation of the actual level of failure of units of vacuum system of dairy milking equipment. Modern problems of improvement of technical systems and technologies in animal husbandry: Bulletin of Kharkiv National Technical University of Agriculture named after Petro Vasylenko, Kharkiv, 2012, Vol. 120, pp. 326–330.
- [30]. *I. A. Shevchenko, E. B. Aliiev, V. O. Drygo, B. T. Poterukha*, Improving the quality of maintenance of milking equipment. Machinery and technologies of agro-industrial complex. UkrNDIPVT named by L. Pogoriloho, 2012, № 12 (39), pp. 37–40.
- [31]. *E. B. Aliev, V. M. Bandura, V. M. Pryshliak, V. M. Yaropud, O. O. Trukhanska*, Modeling of mechanical and technological processes of the agricultural industry, *INMATEH – CUPRINS*, 2018, Vol. 54, Nr. 1, pp. 95–104, ISSN 2068 – 4215.
- [32]. *E. B. Aliiev, Yu. M. Labatyuk*, Numerical modeling of mechanical and technological processes of agro-industrial production, Modern problems of improvement of technical systems and technologies in animal husbandry: Bulletin of the Petro Vasylenko Kharkiv National Technical University of Agriculture, Kharkiv, 2017, Vol. 180, pp. 67–71.
- [33]. *I. A. Babin*, Research of metrological traits of the device for measurement of vacuummetric parameters of the line of washing of a milking parlor. Machinery, energy, transport of agro-industrial complex. VNAU, 2018, № 3 (102), P. 5-10.