

INMATEH -

**AGRICULTURAL
ENGINEERING**

SEPTEMBER - DECEMBER

Editorial

The National Institute of Research-Development for Machines and Installations designed to Agriculture and Food Industry - INMA Bucharest has the oldest and most prestigious research activity in the field of agricultural machinery and mechanizing technologies in Romania.

Short History

- ✓ In 1927, the first research Center for Agricultural Machinery in Agricultural Research Institute of Romania - ICAR (Establishing Law was published in O. D. no. 97/05.05.1927) was established;
- ✓ In 1930, was founded The Testing Department of Agricultural Machinery and Tools by transforming Agricultural Research Centre of ICAR - that founded the science of methodologies and experimental techniques in the field (Decision no. 2000/1930 of ICAR Manager - GHEORGHE IONESCU ȘIȘEȘTI);
- ✓ In 1952, was established the Research Institute for Mechanization and Electrification of Agriculture - ICMA Băneasa, by transforming the Department of Agricultural Machines and Tools Testing;
- ✓ In 1979, the Research Institute of Scientific and Technological Engineering for Agricultural Machinery and Tools - ICSITMUA was founded - subordinated to Ministry of Machine Building Industry - MICM, by unifying ICMA subordinated to MAA with ICPMA subordinated to MICM;
- ✓ In 1996 the National Institute of Research-Development for Machines and Installations designed to Agriculture and Food Industry - INMA was founded - according to G.D. no. 1308/25.11.1996, by reorganizing ICSITMUA, G.D. no. 1308/1996 coordinated by the Ministry of Education and Research G.D. no. 823/2004;
- ✓ In 2008 INMA has been accredited to carry out research and developing activities financed from public funds under G.D. no. 551/2007, Decision of the National Authority for Scientific Research - ANCSno. 9634/2008.

As a result of widening the spectrum of communication, dissemination and implementation of scientific research results, in 2000 was founded the institute magazine, issued under the name of SCIENTIFIC PAPERS (INMATEH), ISSN 1583 – 1019.

Starting with volume 30, no. 1/2010, the magazine changed its name to INMATEH - *Agricultural Engineering*, appearing both in print format (ISSN 2068 - 4215), and online (ISSN online: 2068 - 2239). The magazine is bilingual,

being published in Romanian and English, with a rhythm of three issues / year: January-April, May-August, September-December and is recognized by CNCSIS - with B⁺ category. Published articles are from the field of AGRICULTURAL ENGINEERING: technologies and technical equipment for agriculture and food industry, ecological agriculture, renewable energy, machinery testing, environment, transport in agriculture etc. and are evaluated by specialists inside the country and abroad, in mentioned domains.

Technical level and performance processes, technology and machinery for agriculture and food industry increasing, according to national requirements and European and international regulations, as well as exploitation of renewable resources in terms of efficiency, life, health and environment protection represent referential elements for the magazine „INMATEH - *Agricultural Engineering*”.

We are thankful to all readers, publishers and assessors.

Editor in chief,
Ph. D. Eng. Vladut Nicolae - Valentin

Managing Editorial Board - INMA Bucharest

<u>Editor in Chief</u> VLĂDUȚ NICOLAE - VALENTIN Ph.D.Eng, SR I	
<u>Executive Editor</u> POPA LUCREȚIA Ph.D.Eng, SR I	<u>Logistic support, database</u> MURARU VERGIL , Ph.D.Eng, SR I ȚICU TANIA , techn.
<u>Scientific Secretary</u> CÂRDEI PETRE , math.	<u>Official translators</u> RADU DANIELA-CRISTINA Prof.English, French

E-mail: inmatehjournal@gmail.com**Editorial Board**

- Acad. HERA Cristian - Romania, Honorary President of ASAS - Academy of Agricultural and Forestry Sciences "Gheorghe Ionescu Șişești", member of Romanian Academy;
- Acad. Prof. Ph.D. SIN Gheorghe - Romania, President of ASAS - Academy of Agricultural and Forestry Sciences "Gheorghe Ionescu Șişești";
- Prof.Ph.D. NICOLESCU I. Mihai - Romania, Vicepresident of ASAS - Academy of Agricultural and Forestry Sciences "Gheorghe Ionescu Șişești";
- Hon.Prof.Ph.D.Eng. GĂNGU Vergil - Romania, President of the Department of Agricultural Mechanization of ASAS - Academy of Agricultural and Forestry Sciences "Gheorghe Ionescu Șişești";
- Ph.D. Eng. NICOLESCU C. Mihai - Romania, Scientific General Secretary of the ASAS-Academy of Agricultural and Forestry Sciences "Gheorghe Ionescu Șişești";
- Assoc.Prof. Ph.D. Eng. BELC Nastasia - Romania, IBA Bucharest;
- Ph.D. Eng. BUȚU Alina - Romania, INSB Bucharest;
- Prof. Ph.D. Eng. PARASCHIV Gigel - Romania, P.U. Bucharest;
- Prof. Ph.D.Eng. BIRIȘ Sorin - Romania, P.U. Bucharest;
- Prof. Ph.D. Eng. NICULIȚĂ Petru - Romania, USAMV Bucharest;
- Prof. Ph.D. Eng. VLASE Sorin - Romania, "Transilvania" University Brașov;
- Prof. Ph.D. Eng. ROȘ Victor - Romania, Technical University Cluj Napoca;
- Prof. Ph.D. Eng. FILIP Nicolae - Romania, Technical University Cluj Napoca;
- Prof. Ph.D. Eng. VOICU Gheorghe - Romania, P.U. Bucharest;
- Prof. Ph.D. Eng. GERGEN Iosif - Romania, USAMVB Timișoara;
- Prof. Ph.D. Eng. ȚENU Ioan - Romania, USAMV Iași;
- Assoc.Prof.Ph.D.Eng. BUNGESCU Sorin - Romania, USAMVB Timișoara;
- Prof. Ph.D.Eng. FENYVESILászló - Hungary, Hungarian Institute of Agricultural Engineering Godolo;
- Prof.Ph.D.Eng. KOSUTIC Silvio - Croatia, University of Zagreb;
- Ph.D. BIOCCA Marcello - Italy Agricultural Research Council, Agricultural Engineering Research Unit;
- Prof.Ph.D.Eng. MIHAILOV Nikolay - Bulgaria, University of Rousse;
- Assoc.Prof. Ph.D.Eng. ATANASOV At. - Bulgaria, University of Rousse;
- Assoc.Prof. Ph.D. ERTEKINCan - Turkey, Akdeniz University Antalya;
- Prof. Ph.D.Sc. Eng. VARTUKAPTEINIS Kaspars - Latvia, Latvia University of Agriculture, Institute of Agricultural Machinery;
- ir. HUYGHEBAERT Bruno - Belgium, Walloon Agricultural Research Center CRA-W;
- Prof. Ph.D. Eng. FABRO Dal Inacio Maria - Brazil, Campinas State University;
- Prof. Ph.D. Eng. DE WRACHIEN Daniele - Italy, State University of Milan;
- Prof. Ph.D. Guanxin YAO - P.R.China, Along Agriculture R&D Technology and Management Consulting Co., Ltd;
- Prof. Ph.D. Eng. GONZÁLEZ Omar - Republic of Cuba, Central University "Marta Abreu" de las Villas;
- Assist.Prof.Dr. KABAŞ Önder - Turkey, Akdeniz University;
- Asist.Prof.Dr. SELVÍ Kemal Çağatay - Turkey, Ondokuz Mayıs University.

In the present, *INMATEH - Agricultural Engineering* journal is indexed in the next international databases: **Emerging Sources Citation Index, ULRICHWeb: Global Serials Directory, CABI, SCIPRO, ELSEVIER /SciVerse SCOPUS, Index COPERNICUS International, EBSCO Publishing, Elektronische Zeitschriftenbibliothek**

INMATEH - Agricultural Engineering vol. 53, no.3 / 2017 NATIONAL INSTITUTE OF RESEARCH-DEVELOPMENT FOR MACHINES AND INSTALLATIONS DESIGNED TO AGRICULTURE AND FOOD INDUSTRY - INMA Bucharest 6 Ion Ionescu de la Brad Blvd., sector 1, Bucharest Three issues per year, eISSN: 2068 – 2239 pISSN: 2068 – 4215 Edited by: INMA Bucharest Copyright: INMA Bucharest / Romania
--

CONTENT

		Pag.
1.	<p>CFD ANALYSIS OF AN IMPROVED TLUD BASED EQUIPMENT FOR HEATING SMALL GREENHOUSES AND HOTHOUSES / ANALIZA CFD A UNUI ECHIPAMENT TLUD PENTRU ÎNCĂLZIREA SERELOR ȘI SOLARIILOR DE MICI DIMENSIUNI Prof. Ph.D. Eng. Maican E.¹⁾, Lect. Ph.D. Eng. Duțu I.C.¹⁾, Ph.D. Eng. Matache G.²⁾, Ph.D. Eng. Dumitrescu C.²⁾, Ph.D. Stud. Pavel I.²⁾ ¹⁾“Politehnica” University of Bucharest, Faculty of Biotechnical Systems Engineering / Romania ²⁾Hydraulics and Pneumatics Research Institute INOE 2000 - IHP / Romania</p>	5
2.	<p>DESIGN SUBSTANTIATION OF THE THREE-TIER CENTRIFUGAL TYPE MINERAL FERTILIZERS SPREADER / ОБГРУНТУВАННЯ ДИЗАЙНУ ТРИ РІВНЕВОГО ВІДЦЕНТРОВОГО РОЗКИДАЧА МІНЕРАЛЬНИХ ДОБРИВ Prof. Ph.D. Eng. Kobets A.S.¹⁾, Lect. Ph.D. Eng. Naumenko M.M.¹⁾, Lect. Ph.D. Eng. Ponomarenko N.O.¹⁾, Prof. Ph.D. Agri. Kharytonov M.M.^{1)*}, Lect. Ph.D. Econ. Velychko O.P.¹⁾, Lect. Ph.D. Eng. Yaropud V.M.²⁾ ¹⁾Dnipropetrovsk State Agrarian and Economic University, Faculty of Agrarian Engineering / Ukraine; ²⁾Vinitsky National Agrarian University, Faculty of Agrarian Engineering / Ukraine</p>	13
3.	<p>SOWING MACHINES AND SYSTEMS BASED ON THE ELEMENTS OF FLUIDICS / ВИСІВНІ МАШИНИ ТА СИСТЕМИ НА ОСНОВІ ЕЛЕМЕНТІВ ПНЕВМОНИКИ Prof. D.Sc. Eng. Aulin V.V., Prof. D.Sc. Eng. Chernovol M.I., Ph.D. Eng. Pankov A.O., Ph.D. Eng. Zamota T.M., Ph.D. Eng. Panayotov K.K. Kirovograd National Technical University / Ukraine</p>	21
4.	<p>A NEW BLADE DESIGN OF ROTARY TILLER AND STATIC ANALYSIS USING COMPUTER-AIDED TOOL / BİLGİSAYAR DESTEKLİ TASARIM İLE ROTOTİLLER İÇİN YENİ BİR BIÇAK TASARIMI VE STATİK ANALİZİ Assist. Prof. Dr. Selvi K.Ç.¹⁾ ¹⁾Faculty of Agriculture, Ondokuz Mayıs University, Atakum / Turkey</p>	29
5.	<p>MODERN ASPECTS OF TILLED CROPS PRODUCTIVITY FORECASTING / СУЧАСНІ АСПЕКТИ ПРОГРАМУВАННЯ ВРОЖАЙНОСТІ ПРОСАПНИХ КУЛЬТУР Lect. Ph.D. Biol. Mostypan M.I., Lect. Ph.D. Eng. Vasytkovska K.V., Lect. Ph.D. Agric. Andriyenko O.O., Lect. Ph.D. Agric. Reznichenko V.P. Central Ukrainian National Technical University / Ukraine</p>	35
6.	<p>CHICORY ROOT CROPS COMBINED HARVESTER / КОМБІНОВАНИЙ КОПАЧ КОРЕНЕПЛОДІВ ЦИКОРІЮ Prof. Ph.D. Eng. Baranovsky V.M.¹⁾, P.G. Skalsky O.Ju.¹⁾, Assoc. Prof. Ph. D. Pankiv M.R.¹⁾, Ph.D. Eng. Pastushenko A.S.²⁾ ¹⁾Ternopil Ivan Puluj National Technical University, Ternopil / Ukraine; ²⁾Mykolayiv National Agrarian University, Mykolaiv / Ukraine</p>	41
7.	<p>RESEARCH OF THE DYNAMIC MODEL OF THE FLAX STEMS LINE ARRANGING MECHANISM / ДОСЛІДЖЕННЯ ДИНАМІЧНОЇ МОДЕЛІ МЕХАНІЗМУ ПІДБИВАННЯ СТРИЧКИ СТЕБЕЛ ЛЬОНУ-ДОВГУНЦЯ Prof. Ph.D. Eng. Nalobina O.O.¹⁾, Ph.D. Eng. Gerasymchuk O.P.¹⁾, Ph.D. Eng. Puts V.S.¹⁾, Prof. Ph.D. Eng. Marchuk M.M.²⁾ ¹⁾ Lutsk National Technical University / Lvivska str., 75, Lutsk / Ukraine; ²⁾ National University of Water Management and Nature Resources Use, Rivne / Ukraine</p>	51
8.	<p>SIMULATION OF BULK MATERIALS SEPARATION PROCESS IN SPIRAL SEPARATOR / МОДЕЛЮВАННЯ ПРОЦЕСУ СЕПАРАЦІЇ СИПКИХ МАТЕРІАЛІВ НА СПІРАЛЬНОМУ СЕПАРАТОРІ Lect. Ph.D. Eng. Dudarev I., Lect. Ph.D. Eng. Kirchuk R. Lutsk National Technical University / Ukraine</p>	57
9.	<p>ANALYTICAL ASSESSMENT OF THE PNEUMATIC SEPARATION QUALITY IN THE PROCESS OF GRAIN MULTILAYER FEEDING / АНАЛІТИЧНА ОЦІНКА ЯКОСТІ ПНЕВМОСЕПАРАЦІЇ ПРИ БАГАТОРІВНЕВОМУ ВВЕДЕННІ ЗЕРНА As. Nesterenko A.V., Lect. Ph.D. Eng. Leshchenko S.M., Lect. Ph.D. Eng. Vasytkovskyi O.M., Lect. Ph.D. Eng. Petrenko D.I. Central Ukrainian National Technical University / Ukraine</p>	65
10.	<p>DEVELOPMENT AND EXPERIMENTAL STUDY OF INFRARED BELT DRYER FOR RAPESEED / 用于油菜籽干燥的红外带式干燥机研制和实验 Prof. Ph.D. Eng. Yang M.J.¹⁾, Ms. Stud. Eng. Liu B.¹⁾, Ms. Stud. Eng. Yang Z.R.¹⁾, Ms. Eng. Ding Z.Y.¹⁾, Prof. Ph.D. Eng. Yang L.¹⁾, Prof. Ph.D. Eng. Xie S.Y.¹⁾, Prof. Eng. Chen X.B.²⁾ ¹⁾ Southwest University, College of Engineering and Technology, Chongqing Key Laboratory of Agricultural Equipment for Hilly and Mountainous Regions / P. R. China; ²⁾ Agricultural Machinery Quality Control and Inspection Technology Centre, Nanjing Research Institute for Agricultural Mechanization Ministry of Agriculture / P. R. China</p>	71

DESIGN SUBSTANTIATION OF THE THREE-TIER CENTRIFUGAL TYPE MINERAL FERTILIZERS SPREADER

/

ОБГРУНТУВАННЯ ДИЗАЙНУ ТРИ РІВНЕВОГО ВІДЦЕНТРОВОГО РОЗКИДАЧА МІНЕРАЛЬНИХ ДОБРИВ

Prof. Ph.D. Eng. Kobets A.S.¹⁾, Lect. Ph.D. Eng. Naumenko M.M.¹⁾, Lect. Ph.D. Eng. Ponomarenko N.O.¹⁾, Prof. Ph.D. Agri. Kharytonov M.M.^{1)*}, Lect. Ph.D. Econ. Velychko O.P.¹⁾, Lect. Ph.D. Eng. Yaropud V.M.²⁾

¹⁾Dnipropetrovsk State Agrarian and Economic University, Faculty of Agrarian Engineering / Ukraine

²⁾Vinitsky National Agrarian University, Faculty of Agrarian Engineering / Ukraine

Tel: 0973456227; E-mail: envteam@ukr.net, Dnipro, Ukraine

Keywords: fertilizer, centrifugal spreader, disk distribution quality, movement analysis, spreading features.

ABSTRACT

The mathematical model for substantiation of engineering factors of machineries for centrifugal type mineral fertilization is developed.

It is proposed the design of the disk application for which one could improve evenness of mineral fertilizers spreading by centrifugal type spreaders. Simplified formulas for agricultural engineering usage, giving the opportunity to explain the construction of the fertilizer spreader which provides qualitative spreading for the given bandwidth, are also presented.

РЕЗЮМЕ

Розроблено математичну модель для обґрунтування технологічних параметрів машин для внесення мінеральних добрив відцентрового типу.

Запропонована конструкція диска, застосування якого може покращити рівномірність розсівання добрив розкидачами відцентрового типу. Виведені спрощені для інженерного застосування формули, що дають можливість обґрунтовувати конструкцію дискового розкидача добрив, який забезпечує якісне розсівання на смугу заданої ширини.

INTRODUCTION

The uneven distribution of fertilizers on the surface of the field determines the variability of crops management, yields, the different periods of maturation of crops, debris, deterioration of product quality (Kravchuk et al., 2004; Ning et al, 2015, Velychko, 2015; Vasylieva and Pugach, 2017). More than 90% of modern machinery for fertilizer application equips centrifugal spreaders that successfully transfer granular and crystalline fertilizers to the soil (Petcu et al., 2014; 2015; Tijskens et al., 2008).

Consequently substantiation of design and options of fertilizer distributor's centrifugal tool is very relevant (Allaire and Parent, 2004; Biocca et al., 2015; Nukesheva et al, 2016). The composition of the spreaders includes a disk with blades. This disk is placed under the spout and is rotationally driven around the vertical axis. In this case the fertilizer, which is uniformly distributed by the spout from the hopper, is received on the working surface of the rotating disc. Here it is captured by the vanes and forced into a rotary motion. Under the action of centrifugal forces particles of fertilizer are moving with acceleration on the working surface of the disc along the blades (from the disk centre to the periphery). The fertilizer particles are much faster after the disappearance of the disk (Antille et al., 2013; Šimaet al., 2013). The velocity vector is directed horizontally or at a certain angle to the horizon upwards.

The theory of single part movement on horizontal disk which turns around vertical axis as well as on disk with straight or curve blade was developed in numerous studies (Petcu et al., 2015; Vilette et al., 2005). However, despite the fundamental surveys in the theory of granule and disk interaction and numerous improvements of the working body design, evenness of mineral fertilizer spreading is far from perfect (Reumers et al, 2003).

Centrifugal machines are characterized by a significant separation of unilateral fertilizer to fractions and mixed components (Hofstee, 1992). Significant uneven distribution of fertilizers in width of the spreaders centrifugal type is due to the ballistic properties of the fertilizer particles. The list of ways to improve centrifugal devices include the following: a) the use of conical disks (Ancza et al., 2009; Dong et al., 2013),

b) blades with different length and tapered pointed shape, c) the discs installed in several tiers with inclination to the horizontal and at a considerable height above the ground (Hijazi et al., 2014); d) create a windproof device-specific profile (Fulton, et al., 2001).

MATERIALS AND METHODS

The process of granules distribution on the field surface is multivariate probabilistic in nature. In the general case this process cannot be normal. Meanwhile, the distribution of the granules may be close to normal if we can provide a sufficient number of variants of the granules original climbing from the disk surface. Graphical interpretation of this situation is shown in Fig.1.

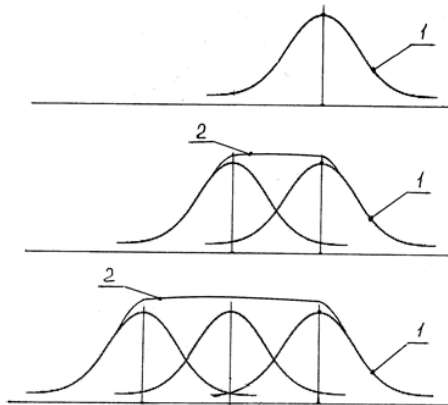

Fig. 1 - Graphical interpretation of fertilizer granules distribution on the field surface in the presence of other (a) two (b) three and (c) vanishing points from a disk surface:
1 – single distribution law; 2 – a plot of the normal distribution

The amount of distributions on the type 1 allows obtaining plots of the type 2, which are close to a normal distribution. Thus, it is necessary to provide the gathering from disk multiple streams of pellets with different initial speeds. It is necessary also to avoid overlapping of flows during the flight.

One of the significant reasons of spreading unevenness is explained in fig.2, where is shown the possible distribution of granules which are thrown by disk in ideal conditions: all granules are thrown with equal speed and evenly (the same amount thrown in a sequence of time), the granules have equal size and as a consequence drop out at the same distance B from the centre, in the case when the machine-tractor aggregate doesn't move.

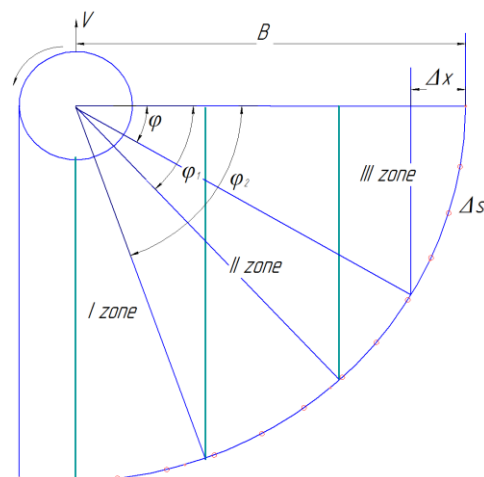

Fig. 2 - Scheme for analysing the uneven fertilizer spreading along the working width if centrifugal working body rotates evenly

If all granules, while disk unloads, are thrown at the equal distance B from the centre, in case the aggregate doesn't move, then while the aggregate is moving the compaction spreading on the periphery of working width becomes more obvious. Based on accepted idealized schematic layout of spreading, it may be concluded that granules amount is attributable to Δx by working width, proportional to appropriate length of semi-circular arc Δs . It gives an opportunity to define intensity of spreading area, which is being processed, in ratio $\Delta s/\Delta x = \omega$. In other words, the ratio of arc length to the working width is corresponding to it. This

gives the opportunity to characterize the intensity of the sowing area, which is being processed, the ratio $\Delta S/\Delta X$.

During the work of the spreader, the upper disk will sow three lanes, the second two and the third - one. It was established that for providing spreading uniformity, it is necessary that materials amount which will drop out from the middle disk additionally on second and third lane be 53.56% of the amount spread by the upper disk. On the first lane from the bottom disk will drop 11.24% fertilizers from the same amount. That way, spreading materials between bands can be evaluated by equation:

$$V=X+0.5366X+0.1124X \quad (1)$$

V – Total fertilizers outlay, X - delivery, provided by the upper disk.

Eq.1 gives an opportunity to estimate that the upper disk should provide delivery 0.61 V ; middle – 0.325 V ; nether – 0.065 V .

The spreader three-tier design was proposed for spreading evenness improving (fig.3).

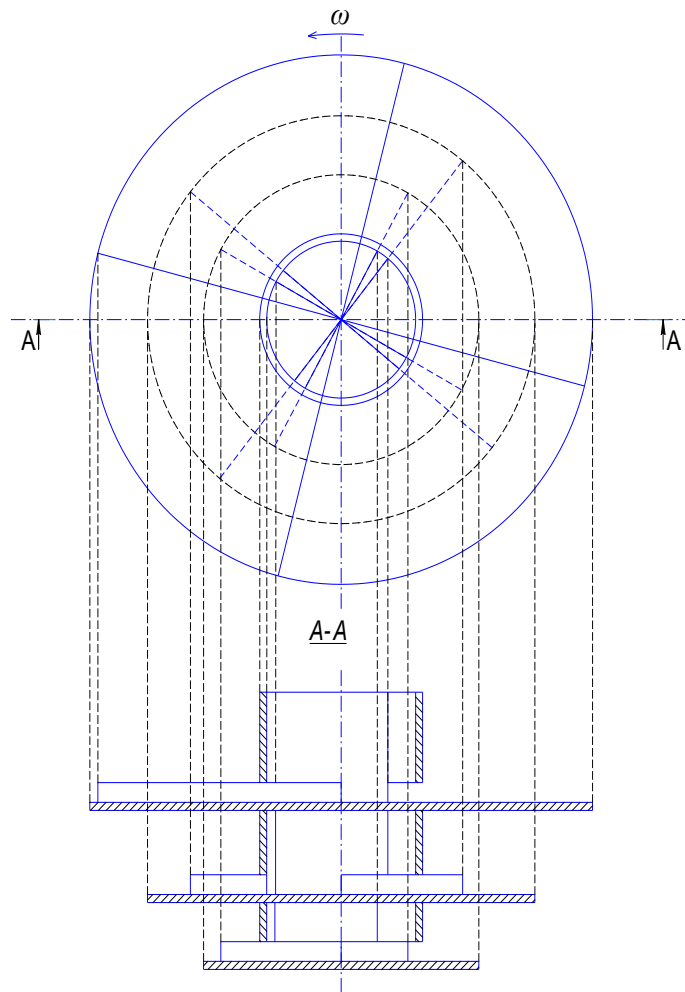

Fig. 3 – Design of spreader's construction

RESULTS

According to the proposed spreader design, it was estimated the distribution of materials flow provided by conical feeder with disks which turns around. The cross section of the feeder is divided by vertical partitions into separate sectors, the area of which is correlated in accordance with the weight of material to prepare separate discs. To ensure the desired distribution of fertilizer flow, it is necessary to determine diameters of three disks of the spreader.

The dependence between disk diameter and flying distance with assigned angular velocity is established. For estimation of escaping velocity of separate granule from a disk, its relative motion is considered.

The design model for movement analyse is shown in fig.4.

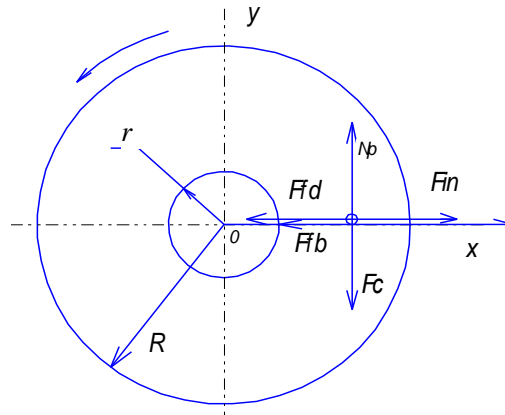

Fig. 4 - Scheme of forces distribution that influences the granule during disk rotation

Vector equation of the granule relative motion has the following form:

$$m\overline{W}_r = \overline{F}_e^{in} + \overline{F}_{fb} + \overline{F}_{fd} + \overline{F}_c^{in} + \overline{N}_p + \overline{N}_d + \overline{P} \quad (2)$$

According to the known granules weight $-m$, angular velocity of the disk ω and friction coefficient f , forces that influence the granule in relative motion along the axis OX (fig. 2) are defined as:

\overline{F}_e^{in} - inertia transfer, $\overline{F}_e^{in} = m\omega^2 x$;

\overline{F}_c^{in} - Coriolis' inertial force, $\overline{F}_c^{in} = 2m\omega\dot{x}$;

F_{fb} – frictional force during interaction with edge; $F_{fb} = 2fm\omega\dot{x}$;

N_p – edge pressure; $N_p = \overline{F}_c^{in}$;

\overline{N}_d – disk reaction; $\overline{N}_d = P$;

P – weight; $P = mg$;

F_{fd} – frictional force when granule is interacting with disk, $F_{fd} = fmg$;

W_r – relative acceleration $W_r = \ddot{x}$; \dot{x} - relative velocity.

According to the above written, the differential equation of granule relative motion can be written in the form:

$$m\ddot{x} = m\omega^2 x - 2fm\omega\dot{x} - fmg,$$

$$\text{or} \quad \ddot{x} + 2n\dot{x} - \omega^2 x = fg \quad (3)$$

where $n = f\omega$

Solving of the differential equation (3) looks like:

$$x = c_1 e^{\omega\sqrt{(1+f^2-f)}t} + c_2 e^{-\omega\sqrt{(1+f^2+f)}t} - \frac{fg}{\omega^2} \quad (4)$$

Whence

$$\dot{x} = c_1 \omega \sqrt{(1+f^2)} e^{\omega\sqrt{(1+f^2-f)}t} - c_2 (\omega\sqrt{(1+f^2+f)} + f) e^{-\omega\sqrt{(1+f^2+f)}t} \quad (5)$$

Given that the initial relative velocity is zero from the equation (5) we get: $c_1 = c_2 (\sqrt{1+f^2} + f)^2$

Taking that at the time $t=0$, $x = r$ equation (4) we have:

$$r = c_2 (\sqrt{1+f^2} + f)^2 + c_2 - \frac{fg}{\omega^2},$$

than

$$c_2 = \frac{r\omega^2 + fg}{((\sqrt{1+f^2} + f)^2 + 1)\omega^2}, \quad \text{and} \quad c_1 = \frac{(r\omega^2 + fg)(\sqrt{1+f^2} + f)^2}{\sqrt{1+f^2} + f}.$$

Thus, formulas (4) and (5) make it possible to determine at any time not only the position of a granule, which moves along the edge, but also its relative velocity. Absolute velocity of the granule can be found as a

vector sum of relative (5) and portable velocity. The vector sum of velocities is determined for the current value of coordinate x by the formula (4), as $V_e = wx$.

The graphical dependence between the current coordinate of the granule on the disk and the absolute speed is made using a table processor *Excel* (fig.5).

In the example above, it was assumed that the relative motion begins at the time when $x=r$, where r – feeder radius ($r = 0.05$ m); angular velocity $w = 56.7$ rad/s; the friction coefficient during granule sliding by disk $f = 0.1$.

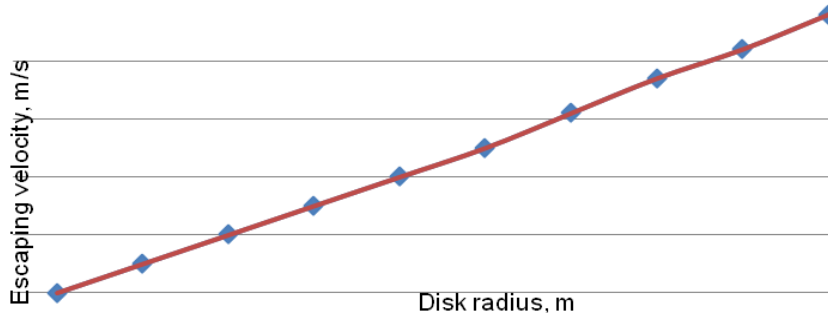

Fig. 5 - The dependence of granule escaping velocity on the disk radius

As shown in Fig. 5, for real values, the length of the edge is within range: $0.05 \leq x \leq 0.4$. Under these conditions, dependence of the absolute velocity on granule coordinate on the disk is close to the linear one. It is clear that the given dependence (for given output values) can be used when assigning the diameter of the disk to provide the required granule escaping velocity from the disk.

To determine the range of flight it is necessary to investigate the movement of a granule that will fly from a spreader with a horizontal initial velocity V_0 .

In the coordinate system XOY differential equations of flight have the form (Fig.6).

$$m\ddot{x} = -Q \cos\alpha; \quad m\ddot{y} = P - Q \sin\alpha,$$

where

Q - air resistance, which we consider like proportional to the flight velocity, i.e. $Q = \mu V$;

P – granule weight; α – angle that formed by velocity vector and axis x .

Taking into account that $V = \sqrt{\dot{x}^2 + \dot{y}^2}$, $\cos\alpha = \frac{\dot{x}}{\sqrt{\dot{x}^2 + \dot{y}^2}}$ and $\sin\alpha = \frac{\dot{y}}{\sqrt{\dot{x}^2 + \dot{y}^2}}$ instead of equations (6)

and (7) we will get

$$m\ddot{x} = -\mu\dot{x}; \tag{8}$$

$$m\ddot{y} = mg - \mu\dot{y} \tag{9}$$

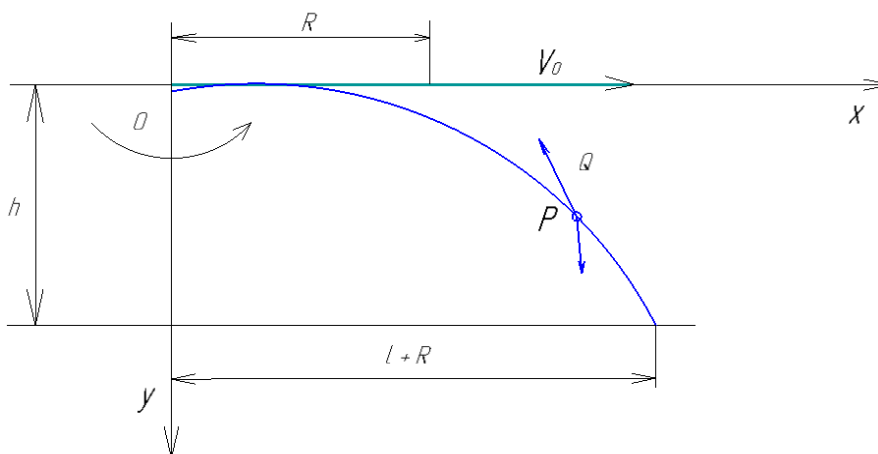

Fig. 6 - Diagram of granules flight analysis

From the differential equation (8) we will get $\frac{d\dot{x}}{\dot{x}} = -\frac{\mu}{m} dt$, i. e. $\ln \dot{x} = -\frac{\mu}{m} t + c$

Given that the escaping velocity is known V_0 we will get:

$$\ln \dot{x} = -\frac{\mu}{m} t + \ln V_0$$

Than $\ln \frac{\dot{x}}{V_0} = -\frac{\mu}{m} t$ from here $\dot{x} = V_0 e^{-\frac{\mu}{m} t}$

Than $x = -V_0 \frac{m}{\mu} e^{-\frac{\mu}{m} t} + C_1$, or taking into account, that the flight began at the edge of disk, where $x_0 = R$

$$x = V_0 \frac{m}{\mu} \left(1 - e^{-\frac{\mu}{m} t} \right) \tag{10}$$

While integrating the differential equation (9) we will get:

$$\frac{dy}{q - \frac{\mu}{m} y} = dt$$

Whence $\ln \left(q - \frac{\mu}{m} y \right) = -\frac{\mu}{m} t + C_2$.

Taking into account that $y_0 = 0$ we will get $\ln \frac{q - \frac{\mu}{m} y}{q} = -\frac{\mu}{m} t$

Whence $1 - \frac{\mu}{qm} y = e^{-\frac{\mu}{m} t}$

i.e. $\frac{\mu}{qm} y = 1 - e^{-\frac{\mu}{m} t}$.

Whence $dy = \frac{qm}{\mu} \int \left(1 - e^{-\frac{\mu}{m} t} \right) dt$

Than $y = \frac{qm}{\mu} t + \frac{qm}{\mu} \cdot \frac{m}{\mu} e^{-\frac{\mu}{m} t} + C_3$

Taking into account that $y_0 = 0$ for C_3 we will get

$$C_3 = -\frac{qm}{\mu} \cdot \frac{m}{\mu}$$

Than

$$y = \frac{qm}{\mu} \left(t - \frac{m}{\mu} \left(1 - e^{-\frac{\mu}{m} t} \right) \right) \tag{11}$$

Formula (11) allows determining flight time of granule depending on height of disk placement (fig. 4).

Formula (10) allows determining the initial escaping velocity of granule, which provides required range of flight (bandwidth) l .

$$V_0 = \frac{(x-R)\mu}{m \left(1 - e^{-\frac{\mu}{m} t} \right)}$$

Thus, the initial velocity, which should provide the disk rotation, can be found from the flight analysis of the granule. The diameter of the disk is determined based on developed dependence shown in fig. 5.

A diagram that qualitatively describes the distribution of granules at the simultaneous screening of three edges is shown in fig.7.

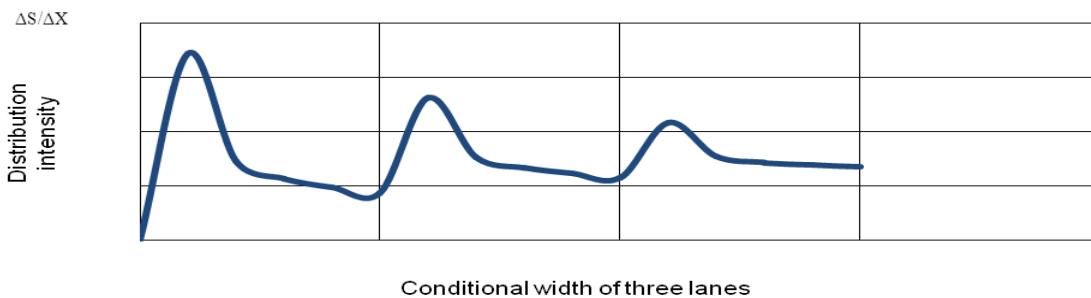

Fig. 7 - The distribution of the three streams

Square curve limited distribution intensity. On each of the three units, the width of the swath is approximately equal. Each strip has approximately the same number of pellets. Given the distribution pattern is idealized. All the pellets fly up from the surface of one of the ribs at the same distance. The reality is that the granules are not the same in shape and volume. They have different aerodynamic characteristics that provide a different range and improve the uniformity of their distribution.

CONCLUSIONS

- The distribution of fertilizer granules on field surface is a multifunctional dependence. Taking into account all input parameters, for an analytical study it is too complicated by mutual influence of factors one to other.
- The three-tier mineral fertilizer spreader designed to provide high-quality spreading without the intersection of streams that escapes from the current tier is substantiated.
- The mathematical model of the process of granules interaction with disk and subsequent spreading of granules is provided. Air resistance affects the final distribution of fertilizer granules on soil surface. Basically, the influence is shown in changing the flight range of individual granules.
- The calculation diagram of spreading disks diameters is shown. Analysis of possible variants of centrifugal working body constructions for mineral fertilizing allowed accepting the spreader scheme, construction of which involves the formation of granules streams location during loading.

ACKNOWLEDGEMENT

The work has been funded by the Ukrainian Ministry of Education and Science.

REFERENCES

- [1] Allaire S. E. and L. E. Parent, (2004), Physical Properties of Granular Organic-based Fertilisers, Part 1: Static Properties, *Biosystems Engineering*, 1, pp.79-87;
- [2] Ancza E., Gindert-Kele A., Hagymássy Z., (2009), The Effect of the Design of the Spreading Device on the Working Width and Evenness of Spreading in the Case of Centrifugal Spreaders Bulletin UASMV Agriculture, Print ISSN, 66 (1), pp.1843-5246;
- [3] Antille D.L., Gallar-Redondo L., Godwin R.J., (2013), Determining the particle size range of organo-mineral fertilisers based on the spreading characteristics of the material, *ASABE Annual International Meeting*, Paper n° 13-1620197;
- [4] Biocca M., Gallo P., Menesatti P., (2013), Aerodynamic properties of six organo-mineral fertiliser particles. *Journal of Agricultural Engineering*, volume XLIV(s2):e83: pp.411-414;
- [5] Dong X., Song J., Zhang J., Wang J., (2013), Working performance and experiment on granular fertilizer spreader with cone disk. in *Nongye Gongcheng Xuebao/Transactions of the Chinese Society of Agricultural Engineering* 29(19), pp.33-40;
- [6] Fulton J. P., Shearer S. A., Chabra G., Higgins S. F., (2001). Performance assessment and model development of a variable-rate, spinner-disc fertilizer applicator. *Transactions of the ASAE*. Vol. 44(5), pp.1071–1081;
- [7] Hijazi B., Cool S., Vangeyte J., Mertens K.C, Cointault F., Paindavoine M., Pieters J.G. (2014) High Speed Stereovision Setup for Position and Motion Estimation of Fertilizer Particles Leaving a Centrifugal Spreader; *Sensors*, 14, pp.21466-21482;
- [8] Hofstee J. W., (1992), Handling and spreading of fertilizers: part 2, physical properties of fertilizer, measuring methods and data. *Journal of Agricultural Engineering Research*, Vol. 53: pp.141–162;
- [9] Kravchuk V.I., Grytsigina M.I., Kovalya S.M., (2004), *Modern tendencies of construction development of agricultural technique (Сучасні тенденції розвитку конструкції сільськогосподарської техніки)*, Ed.Agrarian Science, p.396;
- [10] Ning S., Taosheng X., Liangtu S., Rujing W., & Yuanyuan, W, (2015), Variable rate fertilization system with adjustable active feed-roll length. *International Journal of Agricultural and Biological Engineering*, Vol. 8, Issue 4: pp.19–26;
- [11] Nukesheva S.O., Eskhozhina K.D., Tokusheva M.H., Zhazykbayeva Z.M., (2016), *Substantiation of the Parameters of the Central Distributor for Mineral Fertilizers*, *International journal of environmental & science education*, Vol. 11, №15, pp.7932-7945;

- [12] Petcu A., Ștefan V., Popa L., Toderasc P., Ciupercă R., (2014), Factors influencing the management of granular fertilizers, *Tehnomarket* nr.2, pp.20-21;
- [13] Petcu A.S., Popa L., Stefan V., Ciuperca R., Nedelcu A., Girleanu I.C., Avramescu A.M., Veringa D., Zaica A., Lazar G., (2015), Theoretical research regarding the working process of the fertilizers managing systems by centrifugation. *Annals of the University of Craiova - Agriculture, Montanology, Cadastre Series*, Vol. XLV: pp.174-184,
- [14] Reumers J, Tijskens E., Ramon H., (2003), "Experimental characterisation of the tangential and cylindrical fertiliser distribution pattern from a spinning disc : A parameter study," *Biosystems Engineering* 86(3), pp.327-337;
- [15] Šima T., Nozdrovický L., Krupička J., Dubeňová M., Koloman K. (2013), Granulometric study of dasa 26/13 fertiliser. *MENDELNET*, pp.882-887;
- [16] Tijskens E., Van Liedekerke P., Piron E., Van Geyte J., Cointault F. et al., (2008), Recent results of experimental and Dem modeling of centrifugal fertilizer spreading. *Granular Matter*, Springer Verlag, 10 (4), pp.247 – 255;
- [17] Vasylieva, N. and Pugach, A., (2017); Economic assessment of technical maintenance in grain production of Ukrainian agriculture. *Bulgarian Journal of Agricultural Science*, 23(2), pp.198–203;
- [18] Velychko O., (2015), Logistical system Fortschrittzahlen in the management of the supply chain of a multi-functional grain cooperative, *Economics and Sociology*, Vol. 8, No.1: pp.127-146;
- [19] Vilette S., G Cintault F., Piron E., Chopinet B., (2005), Centrifugal spreading an Analytical Model for the Motion of Fertilizer Particles on a spinning disc, *Biosystems Engineering*, 92(2), pp.157-164.