

PL ISSN 0033-2097, e-ISSN 2449-9544

11'2023



PRZEGLĄD ELEKTROTECHNICZNY

ROK XCIX

WYDAWNICTWO
SIGMA-NOT



cena 70 zł
(w tym 8% VAT)

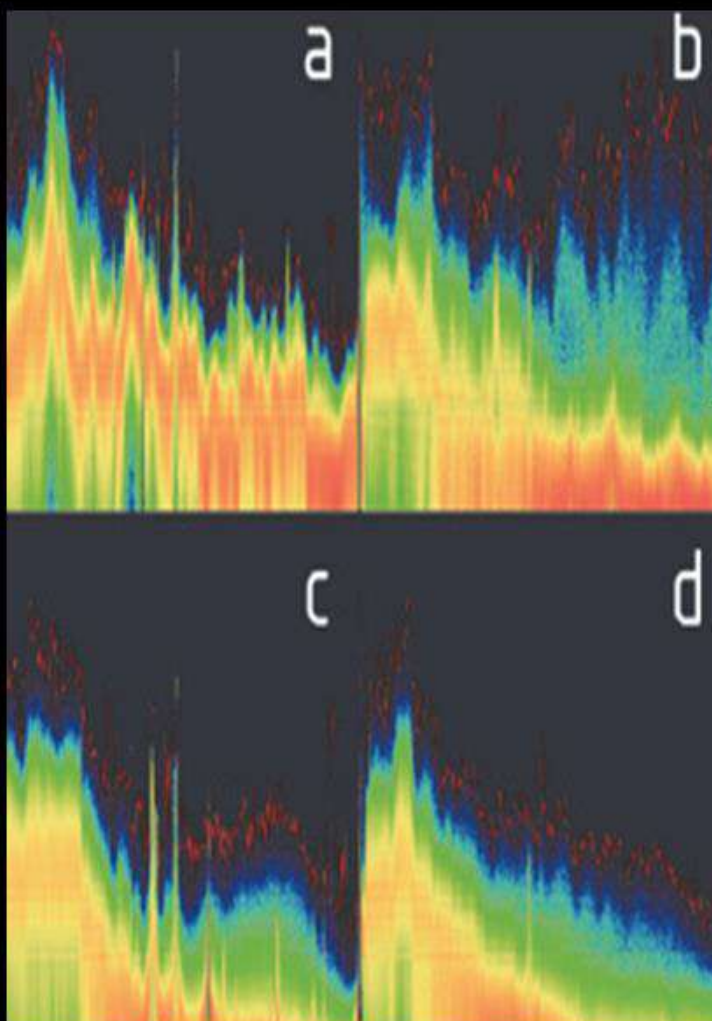

The vibration registration system with the use of a seismic sensor and a real-time spectrum analyzer in the room intended for the TERS-STM system installations - page 284

Contents

01	Amanuel Haftu Kahsay¹, Paweł Regulski¹, Piotr Derugo - AI-based control techniques for maximum power point tracking of photovoltaic systems using a boost converter	1
02	Sandra WŁOSTOWSKA, Julia SZABELA, Adrian CHOJECKI, Piotr BORKOWSKI - Comparison of SQL, NoSQL and TSDB database systems for smart buildings and smart metering applications	7
03	Bernard WYRWOŁ - 1-Wire interface implementation in embedded system with FreeRTOS operating system	13
04	Anna GOLIJANEK-JĘDRZEJCZYK - Dependence of flow coefficient C on orifice thickness with conical inlet	20
05	Wojciech NITA, Sylwester FILIPIAK - Optimization of field upgrades of MV power lines using evolutionary algorithms	26
06	Andrzej FARYŃSKI, Zbigniew ZIÓŁKOWSKI, Przemysław SUL - Generation of high-voltage solitons in a non-linear transmission line	34
07	Paweł KĘPA - Review and analysis of publications of theoretical, field and simulation studies on the legitimacy of using dipped beam headlights	38
08	Jacek KOZYRA, Zbigniew ŁUKASIK, Aldona KUŚMIŃSKA-FIJAŁKOWSKA - Increasing transmission potential of 110 kV alternating current lines	43
09	Mateusz SULIGA - Analysis of the properties of a dual-channel three-phase induction machine with regard state of unsymmetrical work	50
10	Mirosław ŁUKOWICZ, Mateusz MYŚLIWIEC - Problems of detection and modeling of high impedance faults in medium voltage distribution networks	55
11	Paweł SZCZEŚNIAK, Piotr POWROŹNIK, Elżbieta SZTAJMEC - Selected voltage control methods in LV local distribution grids with high penetration of PV	62
12	Djamila CHERIFI, Yahia MILOUD, Mohamed MOSTEFAI – High Performance of Direct Power Control for a Doubly Fed Induction Generator Based on Adaptive Fuzzy Second Order Sliding Mode Controller in Wind Energy Conversion System	66
13	Thirasak PHIANGPRANTHONG, Angkana CHAROENMEE, Adirek JANTAKUN - DVCCTAs-based current-mode MISO filters with separate adjustments for pole frequency, quality factor and amplitude	75
14	Oleh TSURKAN, Ruslan HORBATIUK, Anatolii SPIRIN, Dmytro BORYSIUK, Ihor TVERDOKHLIB, Olena TRUKHANSKA - Research of energy consumption of the vibration machine for surface restoration of working bodies of tillage units	82
15	Ruchika , D.K. Jain - Battery Energy Storage System for Large Scale Penetration of Renewable Energy Sources	88
16	Clement TENGEY, Nnamdi NWULU, Omoseni ADEPOJU, Omowunmi Mary LONGE - Slack-based efficiency assessment of electrical distribution regions in Ghana	94
17	Elbrus AHMEDOV, Elshad SAFIYEV, Sona RZAYEVA, Nijat MAMMADOV, Nigar GANIYEVA, Kubra MUKHTAROVA - Obtaining a graft copolymer of polyethylene by electrodischarge synthesis	100
18	Abdelhak FLIH, Slimane SOUAG, Leila GHOMRI - A K-NN algorithm based fault locating system for HVDC transmission lines	104
19	Hocine GUENTRI, Abdeldjalil DAHBI, Tayeb ALLAOUI - The impact of the power management technique on the transient stability of the electrical network	109
20	Huda D. Bader, Mohammed S. Jarjees, Bassam T. Ahmed - Invasive and Non-Invasive Glucose Monitoring Systems: A Review and Comparative Study	114
21	Elbrus AHMEDOV, Sona RZAYEVA, Nigar GANIYEVA - Improving the lightning resistance of high-voltage overhead power line	121
22	Hameed G. Juma'a, Thamir H. Atyia - Design a 91-Multilevel Inverter Circuit Using Solar PV System Sources	127
23	Mykola LUKIANOV, Ievgen VERBYTSKYI, Natalia STRZELECKA, Ryszard STRZELECKI - Power converter interface for urban DC traction substations - solutions and functionality	134
24	Rafal Emad, Qais Th. Algwari, Ahmed M. A. Sabaawi - Simulating the Barrier Heights Impact on the Performance of Dissimilar Electrodes Metal-Insulator-Metal Diode	141
25	Marwan R. Abed, Oday A. Ahmed, Ghassan A. Bilal - Protection of DC microgrid using Δ CB	146
26	Jamal JAMAL, Muhammad Ruswandi DJALAL - Effect of Outlet at the Bottom of the Drying Chamber on the Performance of Natural Convection Solar Dryers	151
27	Aicha Moulay, Tarak Benslimane, Othmane Abdelkhalek, Khaled Koussa - Detection and Classification of Photovoltaic System Faults using Neural Network	157
28	Zabouri Abdelhamid, Chenafa Mohamed, Naima khalfallah, Bendjeddou Yacine, Kacimi Abderrahmen, Mourad Boufadene - DC-Bus Voltage Control of Self-Excited Induction Generator for Variable-Speed Wind Turbine Generation Including Dynamic Saturation	163
29	Mozhdeh KARAMIFARD¹, Hamed GAROOSI², Seyed Mahdi HOSSEINI-JEBELLI - Performance of 2D Photonic Crystal Fiber on Optical Waveguide Algorithm	170
30	Hau Huu VO, Pavel BRANDSTETTER - Modified Fuzzy Logic PI Speed Controller with Scheduling Boundaries of Integral Time Constant for PMSM Drive	153

Contents

31	Milan Belik, Oleksandr Rubanenko , Olena Rubanenko - Prerequisites for the creation of Digital Twin in the tasks of determining the technical condition of power transformers in specific operating conditions	180
32	D.S.Shylu Sam, P.Sam Paul, Golamari Kiran Kumar Reddy, Nagothu Manideep, Nethikuntla Chakali Venkatesh, Pulikonda Durga Sai Manideep - A new architecture of Thermometer to Binary code encoder for 4 - bit FLASH ADC in 45nm CMOS process	188
33	Oleksandr VOZNYAK, Yurii POLIEVODA, Ihor KUPCHUK, Olena TRUKHANSKA, Ludmila SHVETS, Mykhailo ZAMRIL - Development of object detection algorithm in halftone images	192
34	Paweł KIELAN, Jakub KRZUS - The use of hand movement in space to control mechatronic devices - system design	196
35	Adam DĄBROWSKI, Agata DĄBROWSKA, Marcin DĄBROWSKI – Evaluation of the efficiency of photovoltaic micro power plants in Poland based on the analysis of the monitored facility	200
36	Ewa MANDOWSKA, Renata MAJGIER, Wojciech GRZESIAK, Arkadiusz MANDOWSKI - Spectral analysis of radiation-induced luminescence of a ceramic thick-film substrate	204
37	Konrad BRULIŃSKI, Wiesław KLEMBOWSKI, Aleksandra KISILEWICZ, Marcin MACIEJEWSKI, Elżbieta SZUL-PIETRZAK - A multifunctional system for measuring muscle condition assessment parameters	208
38	Krzysztof GÓRECKI, Kalina DETKA, Paweł GÓRECKI, Przemysław PTAK - Nonlinear thermal models of electronic components	212
39	Michał URBANSKI, Kinga WÓJCICKA, Paweł WÓJCICKI - Fuzzy approach with t-norm arithmetic to analyze measurement uncertainty - concept and algorithm	217
40	Krzysztof CHWASTEK, Branko KOPRIVICA, Marko ROSIĆ, Roman GOZDUR, Piotr GĘBARA - Modelling hysteresis loops of non-oriented electrical steel	221
41	Sebastian DUDZIK, Bartosz Kowalczyk - Forecasting of solar energy production using the NEXO platform and VRM Portal	224
42	Marek GAŁA, Kazimierz JAGIEŁA - Cooperation of the modular multilevel converter with the AC arc furnace	228
43	Anna GAWLAK - Forecast of the balance sheet difference	232
44	Mateusz RAK, Mariusz NAJGEBAUER, Jarosław JĘDRYKA - 3D rapid prototyping technologies in the power industry	236
45	Tomasz POPŁAWSKI, Marek KURKOWSKI - Audit of road lighting installation as a tool to improve energy intensity - case study	241
46	Artur WACHTARCZYK, Janusz SOWIŃSKI - Predictive analysis of measurement data used in systems supervising the operation of electric heating devices at railway junctions	245
47	Jakub SUDER, Tomasz MARCINIAK - Foreign Object Debris detection system using GoogLeNet	249
48	Jerzy AUGUSTYN, Marian KAMPIK, Krzysztof MUSIOŁ - The application of the ellipse fitting algorithm in the measurements of small values of the angular component of the complex voltage ratio	253
49	Damian GONSCZ - The measurement aspects and result estimations in the electromagnetic compatibility tests	257
50	Adam JÓSKO, Wojciech ROMANIK, Mikhail BAHUSLAUSKI, Maciej MAJEK, Maciej SOBCZAK, Maciej ZAKRZEWSKI - System for monitoring the process continuity of the intravenous infusion – development study	261
51	Krzysztof KUBICZEK, Michał GRZENIK, Marian KAMPIK - Measuring systems for testing the basic thermal parameters of AC voltage transducers	265
52	Tadeusz SKUBIS, Adam PILŚNIAK, Anna PIASKOWY - Measurement system for testing the magnetic field uniformity	269
53	Mariusz Talaga, Adrian Halinka - Differential measurements in power system using the synchrophasors	273
54	Ziyad Khalaf Farej, Mohammed Ahmed Hassan - Multi-channel Bonding Effects of the IEEE 802.11ac on the WLAN Performance	277
55	Michał PISKORSKI, Paweł KRUKOWSKI, Witold KOZŁOWSKI, Maciej ROGALA, Paweł DĄBROWSKI, Jaroslav LUTSYK, Dorota A. KOWALCZYK, Maxime Le STER, Karol SAŁAGAN, Aleksandra NADOLSKA, Klaudia TOCZEK, Przemysław PRZYBYSZ, Rafał DUNAL, Wojciech RYŚ, Patryk KREMPIŃSKI, Paweł J. KOWALCZYK - The vibration registration system with the use of a seismic sensor and a real-time spectrum analyzer in the room intended for the TERS-STM system installations	284
56	Michał DOWNAR-ZAPOLSKI, Andrzej KASPROWICZ - Design of a laboratory 3-phase inverter controlled using the PLECS simulation environment	288
57	Zbigniew JĘDRUSIAK, Artur WYMYSŁOWSKI - Review analysis of measurement methods and devices and design of an intelligent electronic system for testing concentrations of harmful chemicals in the air in the food industry	292

Research of energy consumption of the vibration machine for surface restoration of working bodies of tillage units

Abstract. An urgent issue for the development of the agro-industrial complex is the increase in the production resource of the working bodies of tillage units. In the process of performing technological operations on soil cultivation, the working surfaces of bodies of tillage implements of agricultural machines are subject to intensive wear and tear. During interaction with the soil, the working bodies of toothed and disk harrows, huskers, cultivators, combined tillage units, etc. require constant monitoring and checking of their condition. In case of detected deviations from the maximum permissible parameters of the geometric dimensions of the working bodies, it is necessary to replace or repair the latter. When studying all technological processes, one of the main issues is the effective use of energy and material resources. In our case, the main attention should be paid to solving the problem of effective use of energy in the process of vibration processing of the working bodies of tillage tools. This is based on the fact that the material used for vibration treatment of the working bodies of tillage tools in the developed machine is relatively inexpensive and has a long service life. To solve the problem of efficient energy use, it is necessary to determine the power required to drive the vibrating machine. Research of energy consumption of the vibration machine for surface restoration of working bodies of tillage units is presented in the article.

Streszczenie. Pilną kwestią dla rozwoju kompleksu rolno-przemysłowego jest wzrost zasobów produkcyjnych ciał roboczych agregatów uprawowych. W trakcie wykonywania zabiegów technologicznych przy uprawie gleby powierzchnie robocze korpusów narzędzi uprawowych maszyn rolniczych podlegają intensywnemu zużyciu. Podczas interakcji z glebą korpusy robocze bron zębatach i talerzowych, łuskaczy, kultywatorów, agregatów uprawowych itp. wymagają stałego monitorowania i sprawdzania ich stanu. W przypadku wykrycia odchyłeń od maksymalnych dopuszczalnych parametrów wymiarów geometrycznych korpusów roboczych konieczna jest ich wymiana lub naprawa. Podczas badania wszystkich procesów technologicznych jednym z głównych zagadnień jest efektywne wykorzystanie energii i zasobów materiałowych. W naszym przypadku główną uwagę należy zwrócić na rozwiązanie problemu efektywnego wykorzystania energii w procesie obróbki wibracyjnej korpusów roboczych narzędzi uprawowych. Wynika to z faktu, że materiał zastosowany do obróbki wibracyjnej korpusów roboczych narzędzi uprawowych w opracowanej maszynie jest stosunkowo niedrogi i ma długą żywotność. Aby rozwiązać problem efektywnego wykorzystania energii, konieczne jest określenie mocy potrzebnej do napędzania maszyny wibracyjnej. W artykule przedstawiono badania energochłonności maszyny wibracyjnej do renowacji powierzchni korpusów roboczych agregatów uprawowych. (Badania energochłonności maszyny wibracyjnej do renowacji powierzchni korpusów roboczych agregatów uprawowych)

Keywords: energy use, vibration machine, restoration of working bodies of tillage units, oscillation amplitude, angular velocity.

Słowa kluczowe: maszyna wibracyjna, energochłonność, agregaty uprawowe

Introduction

An urgent issue for the development of the agro-industrial complex is the increase in the production resource of the working bodies of tillage units. The issue of introducing new technologies and equipment to solve this urgent task is a promising direction.

Progressive solutions for restoring the working surfaces of tillage implements include methods of vibration finishing and strengthening treatment of the surfaces of parts.

Methods of vibration treatment of the process of restoration of worn surfaces of parts of soil-working working bodies provide a higher degree of strengthening and the level of residual compressive stresses, which allows to increase the fatigue strength of parts.

The method of surface plastic deformation with the use of mechanical vibrations of the processing tool allows you to significantly increase the durability of discs, paws, teeth and other tillage working organs due to changes in the physical and mechanical state and properties of the treated surface, which ensures an increase in their service life.

The development and introduction into the production of methods and means of intensification of finishing and strengthening processing ensures the production of products with the required quality for relatively small costs of energy and money, or the improvement of the processes of restoring the working surfaces of agricultural tools. which is an urgent task today.

Analysis of literary sources and problem statement

When analyzing literary sources that describe a similar technological process [1-6], attention was drawn to the fact that the drive power of vibrating machines was determined

in almost all considered cases only empirically. Obviously, this is due to the fact that the theoretical determination of the power required for the drive is associated with certain difficulties, primarily - with a significant number of factors that affect the course of the process.

But with certain generalizations and simplifications, it is possible to theoretically determine the necessary power for the implementation of this technological process.

Purpose of research

After analyzing the works [1-6], it can be established that in the study of all technological processes, one of the main issues is the effective use of energy and material resources. In our case, the main attention should be paid to solving the problem of efficient use of energy in the process of vibration processing of the working bodies of tillage machines.

Therefore, the purpose of the study is to determine the energy consumption of the developed vibration machine for surface restoration of the working bodies of tillage units.

Presentation of the main material of theoretical research

To solve the problem of efficient energy use, it is necessary to determine the power required to drive the vibrating machine.

In general, the power N_{os} , which is required to oscillate the working chamber with loose loading and the activator of the movement of the working medium, is defined as the time derivative of the work t , which is spent on oscillating the working chamber, the activator and the working medium A_{os} . That is, you can write that

$$(1) \quad N_{os} = \frac{dA_{os}}{dt}.$$

In turn, in the general case, the amount of work A_{os} is defined as the product of the force that performs the work and its displacement in the process of performing the work, i.e.

$$(2) \quad A_{os} = F \cdot a,$$

where F – the sum of the forces to overcome inertial forces on the part of the working chamber and the activator, the elastic forces of their suspensions and the forces of bringing the fluid medium and the processed parts into oscillating motion, N ; a – amplitude of oscillation of working organs, m .

First, let's determine the power required to oscillate the working chamber with the load (abrasive medium and workpieces) and the activator of the working chamber of the vibrating machine.

To solve the given problem, it is necessary to accept some assumptions and simplifications, or to formalize the working process of the working chamber with the activator.

We will assume that the working chamber, together with the activator and the working load, performs only reciprocating movement along the OY axis with the amplitude a and the angular velocity of imbalances ω . All spring elements have the same structural and technological parameters, including stiffness c ; inside the working chamber there is a homogeneous fluid medium with processed parts with a total density of ρ ; the mass of the working chamber together with the activator and the working medium with the processed parts is m .

If we accept these assumptions, then we will get a dependence for determining the work that is necessary to bring the system into oscillatory motion

$$(3) \quad A_{os} = a \cdot [-gm - a \cdot \cos\theta \cdot \sin t\omega \cdot (c - m \cdot \omega) + \zeta \cdot l \cdot R \cdot \rho \cdot \pi \cdot (g \cdot \cos\alpha \cdot \sin t\omega + a)],$$

where l – length of the working chamber, m ; R – radius of the working chamber, m ; ω – angular speed of rotation of the drive unbalanced shaft, rad/s ; ζ – loading factor of the container; c – integral (total) stiffness of system suspensions, N/m ; ρ – density of the working medium (abrasive and processed parts), kg/m^3 ; α – is the angle of inclination of the working chamber axis to the OY axis, rad ; g – acceleration of free fall, 9.81 m/s^2 ; t – processing time, s ; θ – the angle of inclination of the forced force vector to the OY axis (angle of rotation of the imbalance), rad .

Expression (3), which determines the work required to bring the system into oscillating motion, changes its sign over time (it can be with a «-» sign and with a «+» sign).

In our case, work is spent on performing a useful action, that is, it cannot be negative.

Therefore, in the analysis, it is necessary to operate with the value $A = \sqrt{A_{os}^2}$.

The power spent on bringing the system into oscillating motion N is defined as the time derivative of the work function A_{os} (3), i.e.

$$(4) \quad N = N_{os} = a^2 \cdot \omega \cdot [(m \cdot \omega^2 - f_1(c)) \cdot f_2(\theta) \cdot \cos t\omega + 2 \cdot \zeta \cdot l \cdot R \cdot \rho \cdot \pi \cdot g],$$

where $f_1(c)$ – a function that depends on the stiffness of the vibration machine suspension system; $f_2(\theta)$ – a function that depends on the angle of dilution of imbalances.

The functions $f_1(c)$ and $f_2(\theta)$ will be determined as a result of experimental studies. The second component $2 \cdot \zeta \cdot l \cdot R \cdot \rho \cdot \pi \cdot g$ of curly brackets does not depend on the amplitude and frequency of vibration of the vibrating machine, but characterizes the loose medium located inside the working chamber.

It is important to pay attention to the fact that the expression of the function $f_1(c)$ is preceded by the sign «-». This is explained by the fact that in the initial period of time energy is spent on providing the springs with initial potential energy. Then the spring suspension gives its energy and thus reduces the necessary power, which is spent on the oscillation of the entire system.

It should also be emphasized that the greater the stiffness of the spring, the greater its energy (all other conditions being equal) [7].

It can be seen from dependence (4) that the power required to drive the vibrating machine and perform the process of vibration processing of the working bodies of tillage tools depends on the vibration parameters (amplitude and frequency of oscillations) and the stiffness of the suspension system.

Vibration parameters directly affect the quality of the technological process of vibration processing of the working bodies of tillage tools and can be varied within a very limited range.

Experimental equipment

The use of vibration technology allows to fundamentally improve traditional and develop new technological processes. Nowadays, most traditional technologies can be carried out with the help of vibration technology. The main feature of vibrating machines is that they allow you to take into account the frequency properties of the material itself, which additionally reduces the resistance forces during their processing due to the correct selection of the operating mode, this is impossible for other types of machines.

The developed machine for vibration-strengthening processing of parts with a controlled drive (Fig. 1) consists of a frame 2 on which a working chamber 1 is elastically mounted on springs 18 and 11, which is filled with the working medium and processed parts [8]. On the side of the working chamber 1, the shaft 3 of the controlled imbalance vibration exciter 4 is located, which has the ability to remotely change the eccentricity of the center of mass of imbalances 5 and 15. Shaft 3 is connected to the electric motor 7 through an elastic coupling 6. Shaft 3 is installed in the body of the controlled unbalanced vibration exciter 4 on conical bearings 12.

A stationary imbalance 5 is rigidly fixed on the shaft 3, and on the opposite side to the bearings 12 on the shaft 3, two oppositely directed grooves K1 are made diametrically opposite, having a length equal to half the pitch of the screw and in the normal cross-section the shape of a semicircle. Ball keys 19 are placed in the grooves, on which a movable imbalance 15 is installed. The movable imbalance 15 is kinematically connected to the mechanism for adjusting the position 21 of the movable imbalance 15 along the axis of the shaft 3 of the controlled imbalance vibration exciter 4. The mechanism for adjusting the position 21 of the movable imbalance 15 along the axis of the shaft 3 consists of a motion converter 22, made in the form of a screw-nut transmission, which converts the rotational movement of the shaft of the stepper motor (or servo drive) 23, which is attached to the position adjustment mechanism 21, into the translational movement of the movable unbalance 15 along the axis of shaft 3. In the central part of the working chamber 1, a central body 9 (activator) is installed on springs 8, in the central part of the activator 9 along its axis, a shaft 10 is installed on conical bearings 20. The shaft 10 is connected to the electric motor 14 through an elastic coupling 13. A stationary imbalance 24 is rigidly fixed on the shaft 10, and on the opposite side to the bearings 20 on the shaft 10, two diametrically opposite grooves K2 are made, having a length equal to half the pitch of the screw and in

the normal cross-section the shape of a semicircle. Ball pins 25 are placed in the grooves, on which a movable imbalance 26 is installed. The movable imbalance 26 is kinematically connected to the mechanism for adjusting the position 27 of the movable imbalance 26 along the axis of the shaft 10. The mechanism for adjusting the position 27 of the movable imbalance 26 along the axis of the shaft 10 consists of a motion converter 28, made in the form of a screw-nut transmission, which converts the rotational movement of the shaft of the stepper motor (or servo drive) 29, which is attached to the position adjustment mechanism 27, into the translational movement of the movable imbalance 26 along the axis of the shaft 10. The activator 9 is connected to the working chamber 1 by means of elastic walls 16. In the upper part of the working chamber 1 there is a loading neck 17, and in the lower part – an unloading neck 30.

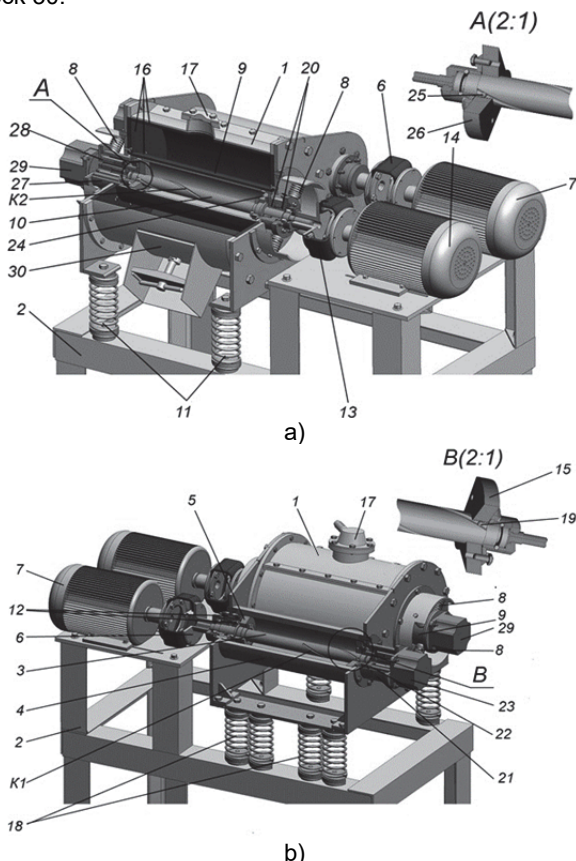

Fig. 1. General view of the vibration machine for surface restoration of working bodies of tillage units: a – front view; b – rear view; 1 – working chamber; 2 – frame of the vibrating machine; 3, 10 – shaft; 4 – unbalanced vibration exciter; 5, 24 – fixed imbalance; 6, 13 – elastic coupling; 7, 14 – electric motors; 8, 11, 18 – springs; 9 – activator; 12, 20 – bearings; 15, 26 – movable imbalance; 16 – elastic walls; 17 – loading neck; 19, 25 – ball keys; 21, 27 – position adjustment mechanism; 22 – motion converter; 23, 29 – servo drive, 28 – motion converter; 30 – discharge nozzle, K1, K2 – oppositely directed grooves.

In agricultural production, this development can be used:

- when cleaning parts of agricultural equipment from soil and scale;
- for rounding the cutting edges of the tool;
- for grinding and decorative polishing;
- as a mixer of granular substances.

The technical characteristics of the developed vibration machine are presented in Table 1.

Table 1. Technical characteristics of the vibrating machine

Index	Value
The volume of the working chamber, m ³	0.03
Oscillation frequency of the working chamber, Hz	0...50
Amplitude of vibration of the working chamber, mm	0...6
Activator oscillation amplitude, mm	0...6
Power of electric motors, kW:	
- working camera	1.5
- activator	0.35
Overall dimensions (length × width × height), mm	1000× 500× 1500

As parts that are processed on the designed machine, we use the working bodies of tillage units (disc harrows, huskers, complex units). At the same time, the parts are placed «in bulk», that is, in an unfastened state.

One of the fields of use of the designed vibrating machine is the finishing of parts. Features of the design of the designed machine determine the implementation of such processes with its help; as rounding of the cutting edge of carbide tools.

The vibrating machine also includes means of measuring and automatically adjusting the parameters of the vibration processing process.

The developed machine intensifies the process of strengthening the working surface of tillage implements, reduces specific energy consumption, improves economic indicators while complying with the current requirements for the manufacture and repair of working bodies of tillage implements.

The results of the experimental study

Based on the obtained results of experimental studies using the developed vibration machine, a statistical analysis of the quality parameters of the obtained products was performed.

Energy consumption N_{os} , kW · h, is characterized by the influence of the five most important factors that determine the quality and energy indicators of parts processing: the amplitude of oscillations of the working chamber a_1 , mm; the amplitude of oscillations of the activator a_2 , mm; angular speed of the drive shaft of the working chamber ω_1 , rad/s; angular speed of the drive shaft of the activator ω_2 , rad/s; processing time t , min.

The study of energy consumption was carried out based on the results of the analysis of functional changes depending on the operating factors, which are recorded in the form of functions:

$$(5) \quad N = f(a_1, a_2, \omega_1, \omega_2, t).$$

Determining the influence of the above factors on the energy consumption of the process during single-factor experiments is associated with significant difficulties and volumes of work. Therefore, it is more expedient to perform a statistical analysis to obtain a functional dependence in the form of a multiple regression of the second order using rotatable central-composite planning of a multivariate experiment [9, 10, 11, 12, 13].

The method of rotatable central-composite planning makes it possible to more accurately obtain a mathematical description of the distribution of data due to an increase in the number of experiments in the central points of the plan matrix and a special choice of the value α .

Rotatable central-composite planning is carried out on five coded levels ($-\alpha, -1, 0, +1, +\alpha$), so the interval of changing factors should be such that the range of its change covers the stationary area of the factor space (Table 2).

Table 2. Factor levels and their variation intervals

Factors	Factor levels					Variation interval
	$-\alpha$	-1	0	+1	$+\alpha$	
Technological process of processing						
a_1 – amplitude of vibrations of the container, mm	2	3	4	5	6	1
a_2 – amplitude of oscillations of the activator, mm	1	2	3	4	5	1
ω_1 – angular speed of the drive shaft of the container, rad/s	115	125	135	145	155	10
ω_2 – angular speed of the drive shaft of the activator, rad/s	115	125	135	145	155	10
t – processing time, min.	45	55	65	75	85	10

A histogram of the distribution of the obtained energy consumption values of the studied process was obtained (Fig. 2).

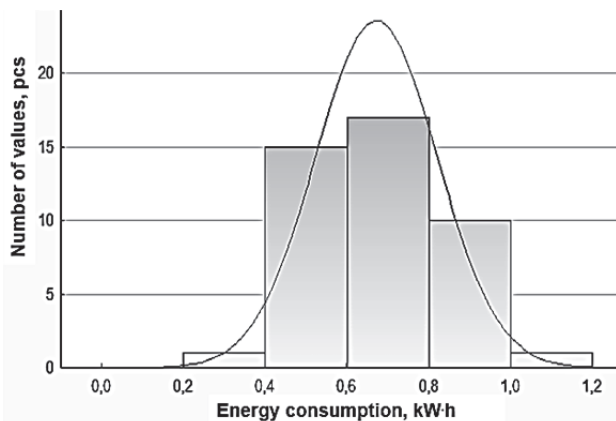

Fig. 2. Histogram of the distribution of the obtained energy consumption values N , kW · h of the studied process

After processing the experimental data in the statistical environment «Statistica 10.0», the coefficients of the complex equations of the 2nd order multiple regression were obtained.

After checking the significance of the coefficients of the regression equation according to the Student's criterion and the adequacy of the mathematical model to the experimental data set according to the Fisher criterion, a regression equation was obtained, which describes the change in the required drive power of the working organs of the vibrating machine from the stiffness of the spring suspension and the angle of dilution of imbalances for a rational value of the amplitude $a = 4 \cdot 10^{-3}$ m and the angular velocity of oscillation $\omega = 146.5$ s $^{-1}$:

$$(6) \quad N = (3027,9 - 1806,7 \cdot \theta) \exp(-0,5 \cdot c).$$

In the theoretical part, the dependence of the required drive power of the vibrating machine on its parameters of the working organs is defined (4). It was indicated that the functions $f_1(c)$ and $f_2(\theta)$ will be refined as a result of conducting experimental studies.

According to the regression equation (6), the dependence of the change in the required power of the drive of the working bodies of the vibrating machine on the equivalent stiffness of the suspension system and the angle of dilution of the imbalances was constructed (Fig. 2). At the same time, the theoretical dependence of the required power is represented by curves, and the experimental data are represented by points (Fig. 3).

According to the regression equation (6), the response surface is constructed that functionally describe the change:

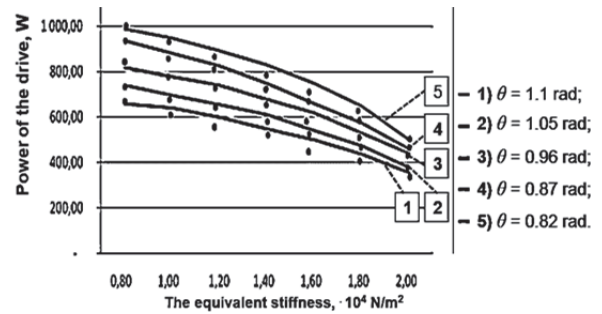
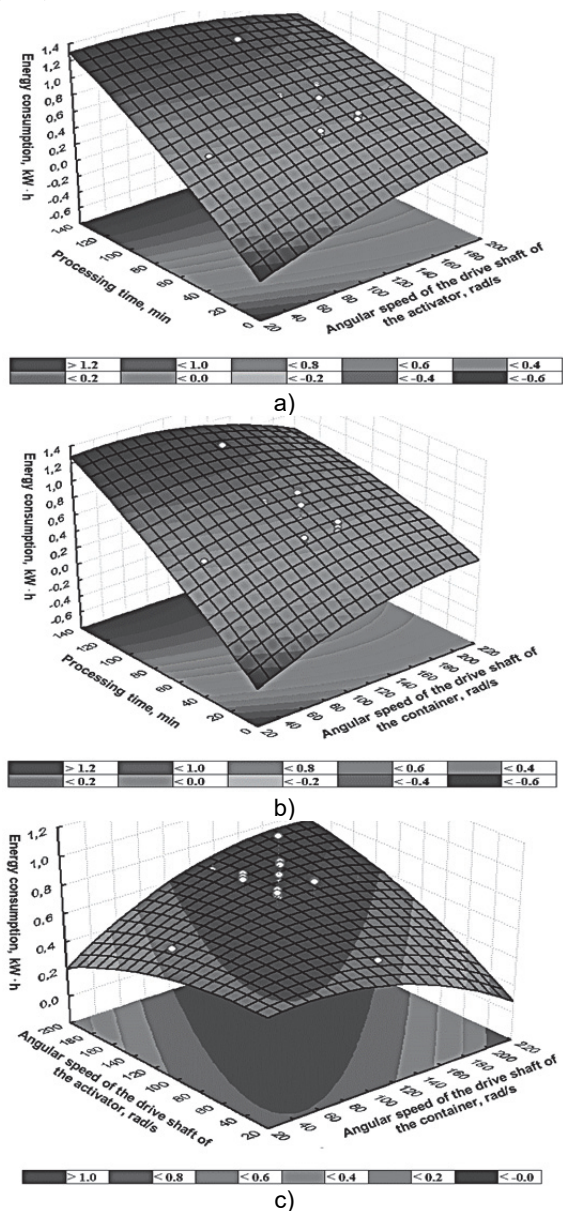

Fig. 3. Dependence of the required power on the equivalent stiffness of the suspension system and the angle of dilution of imbalances

- Fig. 4 – energy consumption for the actuator of the working bodies from change: a – time of processing and angular speed of the drive shaft of the activator as a function $N = f(t; \omega_2)$; b – time of processing and angular speed of the drive shaft of the working chamber as a function $N = f(t; \omega_1)$; c – angular speed of the drive shaft of the activator and angular speed of the shaft of the working chamber as a function $N = f(\omega_2; \omega_1)$; d – time of processing and amplitude of oscillation of the activator as a function $N = f(t; a_2)$;



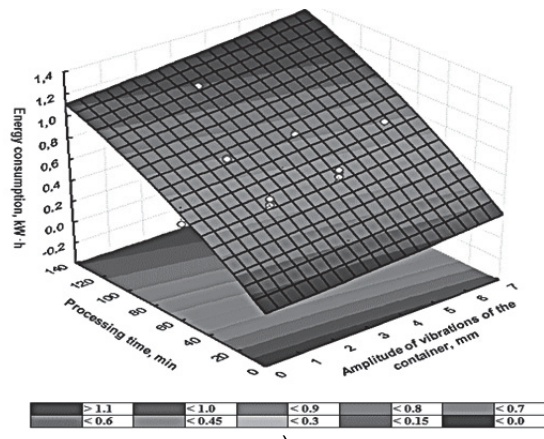
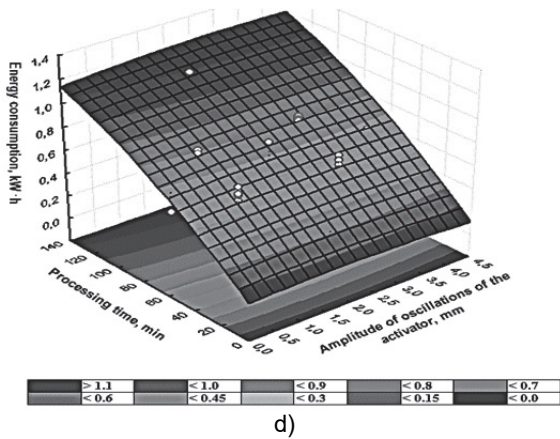

Fig. 4. The response surface as a function:
 a – $N = f(t; \omega_2)$; b – $N = f(t; \omega_1)$; c – $N = f(\omega_2; \omega_1)$; d – $N = f(t; a_2)$

- Fig. 5 – energy consumption for the actuator of the working bodies depending on the change: a – angular velocity of the drive shaft of the activator and amplitude of oscillations of the activator as a function $N = f(\omega_2; a_2)$; b – angular speed of the drive shaft of the working chamber and amplitude of oscillation of the activator as a function $N = f(\omega_1; a_2)$; c – time of processing and amplitude oscillations of the working chamber as a function $N = f(t; a_1)$; d – angular speed of the drive shaft of the activator and amplitude of oscillations of the working chamber as a function $N = f(\omega_2; a_2)$; e – angular speed of the drive shaft of the working chamber and amplitude of oscillations of the working chamber as a function $N = f(\omega_1; a_1)$; f – activator oscillation amplitudes and amplitudes of fluctuations of the working chamber as a function $N = f(a_2; a_1)$.

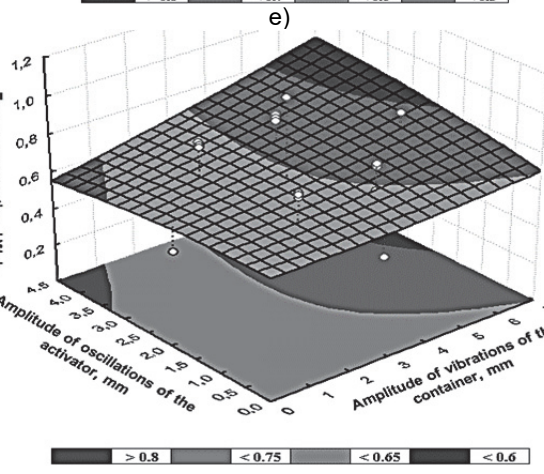
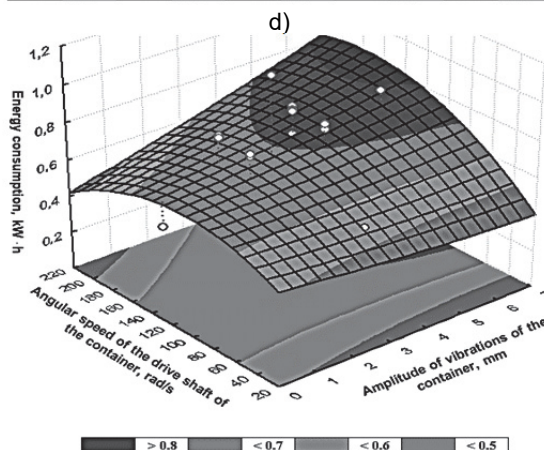
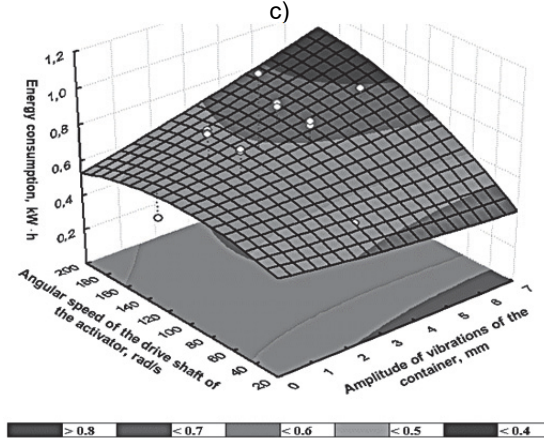

Fig. 5. The response surface as a function:
 a – $N = f(\omega_2; a_2)$; b – $N = f(\omega_1; a_2)$; c – $N = f(t; a_1)$; d – $N = f(\omega_2; a_1)$;
 e – $N = f(\omega_1; a_1)$; f – $N = f(a_2; a_1)$

Analysis of constructed response surfaces of functional change of micro-uniformities and hardness of the surface of the part and the energy consumption of the drive of the working organs of the vibrating machine shows that the optimum function is determined by the factors ω_1, ω_2, t .

Conclusions

1. On the basis of the analysis of known designs of vibrating machines and the processes of finishing and strengthening processing of parts, a vibrating machine with an unbalanced activator of the movement of the working medium was developed for the surface restoration of the working bodies of tillage units.

2. According to the results of experimental studies, it was established that the energy consumption of the vibrating machine is in the range from 0.2 to 0.8 kWh when the angular speed of the drive shaft of the activator is changed from 20 to 200 rad/s and the angular speed of the drive shaft of the working chamber from 20 to 220 rad/s.

3. It was established that the acceptable values of the indicators of the process of vibration strengthening of parts were obtained with the following rational values of the parameters of the vibration machine: amplitude of vibration of the working chamber $4 \cdot 10^{-3}$ m; rotation frequency of the drive shaft of the activator and working chamber 146.5 rad/s; the angle of dilution of imbalances is 0.96 rad.

Authors:

TSURKAN Oleh – *Doctor of Technical Sciences, Associate Professor, Separated structural unit «Ladyzhyn Professional College of Vinnytsia National Agrarian University» (24321, 5 Kravchik Petro St., Ladyzhyn, Vinnytsia Region, Ukraine, e-mail: tsurkan_ov76@ukr.net);* HORBATIUK Ruslan – *PhD in Engineering, Separated structural unit «Ladyzhyn Professional College of Vinnytsia National Agrarian University» (24321, 5 Kravchik Petro St., Ladyzhyn, Vinnytsia Region, Ukraine, e-mail: ruslangorbatyuk@gmail.com);* SPIRIN Anatolii – *PhD in Engineering, Associate Professor, Separated structural unit «Ladyzhyn Professional College of Vinnytsia National Agrarian University» (24321, 5 Kravchik Petro St., Ladyzhyn, Vinnytsia Region, Ukraine, e-mail: spirinanatoly16@gmail.com);* BORYSIUK Dmytro – *PhD in Engineering, Associate Professor, Faculty of Mechanical Engineering and Transport, Vinnytsia National Technical University (21021, 95 Khmel'nyts'ke Highway, Vinnytsia, Ukraine, e-mail: bddv30@gmail.com);* TVERDOKHLIB Ihor – *PhD in Engineering, Associate Professor, Faculty of Engineering and Technology, Vinnytsia National Agrarian University (21008, 3 Sonyachna str., Vinnytsia, Ukraine, e-mail: igor_tverdokhlib@yahoo.com);* TRUKHANSKA Olena – *PhD in Engineering, Associate Professor, Faculty of Engineering and*

Technology, Vinnytsia National Agrarian University (21008, 3 Sonyachna str., Vinnytsia, Ukraine, e-mail: seaswallow@ukr.net)

REFERENCES

- [1]. Nikolaenko A. P. Improvement of the design of vibrating machines with a U-shaped container, *Bulletin of the National Technical University «KhPI». Series «New Solutions in Modern Technologies»*, (2013), nr. 56, 15-21.
- [2]. Burlakova G. Yu. Dynamic equations of motion and kinematic characteristics of a practical model of a container for processing small car parts, *Bulletin of the Azov State Technical University. Series «Technical sciences»*, (2014), nr. 28, 184-187.
- [3]. Babichev A. P., Zelentsov L. K., Samodumsky Yu. M. Design and operation of vibration machines for processing parts, Rostov-on-Don: Publishing house of the RTU, 1981. 160 p.
- [4]. Babichev A. P., Babichev I. A. Fundamentals of vibration technology, Rostov-on-Don: Publishing Center of DSTU, 1998. 624 p.
- [5]. Kartashov I. N., Shainsky E. M., Vlasov V. A. Treatment of parts with free abrasives in vibrating tanks, Kyiv: Scientific thought, 1974. 83 p.
- [6]. Sidashenko O. I., Naumenko O. A., Skoblo T. S., Tikhonov O. V. and others. Repair of machines and equipment, Kharkiv: Miskdruk, 2010. 744 p.
- [7]. Bulgakov V., Chernysh O., Yaremenko V., Berezovyi M. Theoretical mechanics, Kyiv: Center for educational literature, 2019. 705 p.
- [8]. Sereda L. P., Beryk P. S., Pisarenko V. G., Bokovy E. F., Gorbatyuk R. M. Device for vibration processing of parts, Ukraine, Patent UA 99052635, 2001. (in Ukrainian)
- [9]. Boyko N. G., Ustylenko T. A. Theory and methods of engineering experiment, Donetsk, 2009. 158 p.
- [10]. Dmytro Borysiuk, Anatoly Spirin, Ihor Kupchuk, Ihor Tverdokhlib, Viacheslav Zelinskyi, Yevhenii Smyrnov1, Vitaliy Ognevyy. The methodology of determining the place of installation of accelerometers during vibrodiagnostic of controlled axes of wheeled tractors, *Przegląd elektrotechniczny*, (2021), nr. 10, 44-48. DOI: 10.15199/48.2021.10.09
- [11]. Oleh Tsurkan, Dmytro Prysiazhniuk, Anatolii Spirin, Dmytro Borysiuk, Ihor Tverdokhlib, Yurii Polievoda. Research of the process of vibrozone drying of grain, *Przegląd elektrotechniczny*, (2022), nr. 12, 329-333. DOI: 10.15199/48.2022.12.76
- [12]. Oleh Tsurkan, Dmytro Prysiazhniuk, Anatolii Spirin, Dmytro Borysiuk, Ihor Tverdokhlib, Serhii Hrushetskyi. Research of the energy parameters of the vibro-ozonation complex, *Przegląd elektrotechniczny*, (2023), nr. 6, 39-44. DOI: 10.15199/48.2023.06.08
- [13]. Spirin A., Borysiuk D., Tsurkan O., Tverdokhlib I., Veselovska N., Edl M. Ways of Intensification of Grass Seed Production, *Journal of Engineering Sciences*, (2023), Vol. 10, Issue 1, F11-F19. DOI: 10.21272/jes.2023.10(1).f3