



Всеукраїнський науково-технічний журнал

All-Ukrainian Scientific & Technical Journal

ISSN 2520-6168 (Print)

DOI:10.37128/2520-6168-2024-4

Machinery  
Energetics  
Transport  
of Agribusiness



ТЕХНІКА  
ЕНЕРГЕТИКА  
ТРАНСПОРТ АПК



*Науковий журнал*

**ТЕХНІКА,  
ЕНЕРГЕТИКА,  
ТРАНСПОРТ АПК**

*№ 4 (127) / 2024*

**м. Вінниця – 2024**



*Scientific Journal*

**Engineering,  
Energy, Transport  
AIC**

*Vol 127, № 4 / 2024*

**Vinnytsia – 2024**

**ТЕХНІКА,  
ЕНЕРГЕТИКА,  
ТРАНСПОРТ АПК**

Заснований у 1997 році під назвою «Вісник Вінницького державного сільськогосподарського інституту».  
Правонаступник видання: Збірник наукових праць Вінницького національного аграрного університету. Серія: Технічні науки.  
Свідоцтво про державну реєстрацію засобів масової інформації  
КВ № 16644–5116 ПР від 30.04.2010 р.

*Науковий журнал «Техніка, енергетика, транспорт АПК» / Редколегія: Токарчук О.А. (головний редактор) та інші. Вінниця, 2024. № 4 (127). С. 1-99.*

*Друкується за рішенням Вченої ради Вінницького національного аграрного університету (протокол № 6 від 24.12.2024 р.)*

*Свідоцтво про державну реєстрацію засобів масової інформації №21906-11806 Р від 12.03.2016р.*

*Журнал «Техніка, енергетика, транспорт АПК» включено до переліку наукових фахових видань України з технічних наук (Категорія «Б», Наказ Міністерства освіти і науки України від 02.07.2020 року №886).*

*Згідно рішення Національної ради України з питань телебачення та радіомовлення від 25.04.2024 р. №1337 науковому журналу «Техніка, енергетика, транспорт АПК» присвоєно ідентифікатор media R30-05173.*

*Журналу «Техніка, енергетика, транспорт АПК» присвоєно ідентифікатор цифрового об'єкта (Digital Object Identifier – DOI).*

*Журнал включений до міжнародних наукометричних баз і каталогів наукових праць:*

- *Index Copernicus Value з 2018 року, сайт: <https://journals.indexcopernicus.com/search/details?id=47074>;*

- *Національної бібліотеки України ім. В.І. Вернадського, сайт: <http://www.irbis-nbuv.gov.ua>;*

- *Google Академія, сайт: <https://scholar.google.com.ua/citations?user=A5layLAAAAAJ&hl=uk>;*

- *CrossRef, сайт: <https://www.crossref.org>.*

**Головний редактор**

**Олексій ТОКАРЧУК** – к.т.н., доцент,  
Вінницький національний аграрний університет

**Заступник головного редактора**

**Віталій ЯРОПУД** – к.т.н., доцент,  
Вінницький національний аграрний університет

**Відповідальний секретар**

**Юрій ПОЛЄВОДА** – к.т.н., доцент,  
Вінницький національний аграрний університет

**Члени редакційної колегії**

**Олег ЦУРКАН** – д.т.н., професор,  
Вінницький національний аграрний університет

**Сергій ШАРГОРОДСЬКИЙ** – к.т.н., доцент,  
Вінницький національний аграрний університет

**Володимир БУЛГАКОВ** – д.т.н., професор,  
академік НААН України, Національний університет  
біоресурсів і природокористування України

**Валерій ГРАНЯК** – к.т.н., доцент,  
Вінницький національний аграрний університет

**Ростислав ІСКОВИЧ-ЛОТОЦЬКИЙ** – д.т.н.,  
професор, Вінницький національний технічний  
університет

**Анатолій СПІРІН** – к.т.н., доцент,  
Вінницький національний аграрний університет

**Юлія САЛЕНКО** – д.т.н., професор, Кременчуцький  
національний університет імені Михайла  
Остроградського

**Олена СОЛОНА** – к.т.н., доцент,  
Вінницький національний аграрний університет

**Ігор КУПЧУК** – к.т.н., доцент,  
Вінницький національний аграрний університет

**Ігор ТВЕРДОХЛІБ** – к.т.н., доцент,  
Вінницький національний аграрний університет

**Ярослав ІВАНЧУК** – д.т.н., професор,  
Вінницький національний технічний університет

**Зарубіжні члени редакційної колегії**

**Йордан МАКСИМОВ** – д.т.н., професор,  
Технічний університет Габрово (Болгарія)

**Аудріус ЖУНДА** – к.т.н., доцент,  
Університет Вітовта Великого (Литва)

відповідальний секретар редакції – **Полєвода Ю.А.** к.т.н., доцент,

літературний редактор української та іноземних мов – **Погранична Н.М.**,

Адреса редакції: 21008, Вінниця, вул. Сонячна 3, Вінницький національний аграрний університет, тел. (0432) 46–00–03

Сайт журналу: <http://tetapk.vsau.org/>

Електронна адреса: [pophv@ukr.net](mailto:pophv@ukr.net)

**ENGINEERING,  
ENERGY,  
TRANSPORT AIC**

Journal of scientific, industrial and educational direction  
Publisher: Vinnytsia National Agrarian University

It was founded in 1997 under the name "Bulletin of the Vinnytsia State Agricultural Institute".  
Successor publication: Collection of Scientific Works of the Vinnytsia National Agrarian University. Series: Technical sciences.  
Certificate of state registration of mass media  
KV No. 16644–5116 PR dated 04/30/2010

*Scientific journal "Technology, Energy, Transport AIC" / Editorial board: Tokarchuk O.A. (chief editor) and others. Vinnytsia, 2024. Vol. 127, № 4, P. 1-99.*

*Printed by decision of the Academic Council of the Vinnytsia National Agrarian University (protocol №. 6 dated December 24, 2024)*

*Certificate of state registration of mass media No. 21906-11806 R dated March 12, 2016.*

*The journal "Technology, Energy, Transport AIC" is included in the list of technical scientific publications of Ukraine (Category "B", Order of the Ministry of Education and Science of Ukraine dated 07.02.2020 No. 886).*

*According to the decision of the National Council of Ukraine on Television and Radio Broadcasting dated 04/25/2024 No. 1337, the scientific journal " Technology, Energy, Transport AIC " was assigned the media identifier R30-05173.*

*The journal " Technology, Energy, Transport AIC " has been assigned a digital object identifier (DOI).*

*The journal is included in the international scientometric bases and catalogs of scientific works:*

- *Index Copernicus Value since 2018, website: <https://journals.indexcopernicus.com/search/details?id=47074>;*
- *National Library of Ukraine named after V.I. Vernadskyi, website: <http://www.irbis-nbuv.gov.ua>;*
- *Google Academy, website: <https://scholar.google.com.ua/citations?user=A5layLAAAAAJ&hl=uk>;*
- *CrossRef, website: <https://www.crossref.org>.*

**Chief editor**

**Olexii TOKARCHUK** – Candidate of Technical Sciences, Associate Professor, Vinnytsia National Agrarian University (Ukraine)

**Deputy editor-in-chief**

**Vitalii YAROPUD** – Candidate of Technical Sciences, Associate Professor, Vinnytsia National Agrarian University (Ukraine)

**Responsible secretary**

**Yuriy POLIEVODA** – Candidate of Technical Sciences, Associate Professor, Vinnytsia National Agrarian University (Ukraine)

**Members of the editorial board**

**Oleg TSURKAN** – Doctor of Technical Sciences, Full Professor, Vinnytsia National Agrarian University (Ukraine)

**Volodymyr BULGAKOV** – Doctor of Technical Sciences, Full Professor, Acad. NAAS, National University of Life and Environmental Sciences of Ukraine (Ukraine)

**Rostislav ISKOVICH-LOTOTSKY** – Doctor of Technical Sciences, Full Professor, Vinnytsia National Technical University (Ukraine)

**Yuliia SALENKO** – Doctor of Technical Sciences, Full Professor, Kremenchuk Mykhailo Ostrohradskyi National University (Ukraine)

**Igor KUPCHUK** – Candidate of Technical Sciences, Associate Professor, Vinnytsia National Agrarian University (Ukraine)

**Serhii SHARHORODSKYI** – Candidate of Technical Sciences, Associate Professor, Vinnytsia National Agrarian University (Ukraine)

**Valerii HRANIAK** – Candidate of Technical Sciences, Associate Professor, Vinnytsia National Agrarian University (Ukraine)

**Anatoly SPIRIN** – Candidate of Technical Sciences, Associate Professor, Vinnytsia National Agrarian University (Ukraine)

**Olena SOLONA** – Candidate of Technical Sciences, Associate Professor, Vinnytsia National Agrarian University (Ukraine)

**Igor TVERDOKHLIB** – Candidate of Technical Sciences, Associate Professor, Vinnytsia National Agrarian University (Ukraine)

**Yaroslav IVANCHUK** – Doctor of Technical Sciences, Full Professor, Vinnytsia National Technical University (Ukraine)

**Foreign members of the editorial board**

**Jordan Todorov MAXIMOV** – Doctor of Technical Sciences, Full Professor, Technical University of Gabrovo (Bulgaria)

**Audrius ŽUNDA** – Ph.D., Associate Professor, Vytautas Magnus University (Kaunas, Lithuania)

editor-in-chief – **Yurii POLIEVODA**, Candidate of Technical Sciences, Associate Professor,  
literary editor of Ukrainian and foreign languages – **Natalia POGRANICHNA**

Address of the editorial office: 21008, Vinnytsia, str. Sonyakna 3, Vinnytsia National Agrarian University, tel. (0432)46-00-03

The magazine's website: <http://tetapk.vsau.org/>

E-mail address: [pophv@ukr.net](mailto:pophv@ukr.net)



## ЗМІСТ

**I. ПРИКЛАДНА МЕХАНІКА. МАТЕРІАЛОЗНАВСТВО. ГАЛУЗЕВЕ МАШИНОБУДУВАННЯ**

<i>ПАЛАДІЙЧУК Юрій Богданович, ТЕЛЯТНИК Інна Анатоліївна, КУБАЙ Марина Григорівна</i> <b>МЕТАЛОГРАФІЧНЕ ДОСЛІДЖЕННЯ ЗМІНИ СТРУКТУРИ ДЕФОРМОВАНОГО ШАРУ МЕТАЛУ ПРИ ГІДРОІМПУЛЬСНОМУ ВИГЛАЖУВАННІ.....</b>	<b>7</b>
<i>ПАНАСЕНКО Володимир Володимирович, ДЕЙНЕКА Дмитро Миколайович</i> <b>ОСОБЛИВОСТІ ПРОЦЕСУ ДИСТИЛЯЦІЇ ДІЕТІЛАМІНУ З ВОДНОГО РОЗЧИНУ ХЛОРИДУ КАЛЬЦІЯ.....</b>	<b>23</b>
<i>ТРУХАНСЬКА Олена Олександрівна, ГАДАЙЧУК Максим Юрійович</i> <b>АНАЛІЗ КОНСТРУКТИВНО-ТЕХНОЛОГІЧНИХ АСПЕКТІВ ФУНКЦІОНУВАННЯ КОПАЧІВ КОРЕНЕПЛОДІВ ЦИКОРІЮ.....</b>	<b>30</b>
<i>ШТУЦЬ Андрій Анатолійович, БАБИН Ігор Анатолійович, ЛУЦ Павло Михайлович</i> <b>ДОСЛІДЖЕННЯ ПРОЦЕСІВ ШТАМПУВАННЯ ОБКОЧУВАННЯМ ПРИ ФОРМУВАННІ ФЛАНЦІВ ТРУБОПРОВІДІВ.....</b>	<b>38</b>

**II. АГРОІНЖЕНЕРІЯ**

<i>КРАВЕЦЬ Світлана Миколаївна</i> <b>ПЕРСПЕКТИВИ РОЗВИТКУ ВОДНЕВОЇ ЕНЕРГЕТИКИ: ІННОВАЦІЙНІ ТЕХНОЛОГІЇ ЯК КЛЮЧ ДО ЗДЕШЕВЛЕННЯ «ЗЕЛЕНОГО» ВОДНЮ.....</b>	<b>46</b>
<i>РЯБОШАПКА Вадим Борисович</i> <b>КОМПЛЕКСНЕ ДОСЛІДЖЕННЯ КРИТЕРІЇВ ДОЦІЛЬНОСТІ ВИРОБНИЦТВА БІОДИЗЕЛЬНОГО ПАЛИВА НА БАЗІ ФЕРМЕРСЬКИХ ГОСПОДАРСТВ.....</b>	<b>57</b>
<i>ТРУХАНСЬКА Олена Олександрівна, ПЕРХАЙЛО Богдан Павлович</i> <b>ТЕНДЕНЦІЇ ЗАСТОСУВАННЯ НОВИХ ТЕХНОЛОГІЙ І МАШИН ДЛЯ ЗБИРАННЯ БІОНЕРГЕТИЧНИХ КУЛЬТУР.....</b>	<b>70</b>
<i>ШВЕЦЬ Людмила Василівна, ПАВЛЮК Дарина Олександрівна</i> <b>ДОСЛІДЖЕННЯ ТА РОЗРОБКА АГРЕГАТУ ДЛЯ ЗРІЗАННЯ ГІЛОК ІЗ ПОДРІБНЕННЯМ І ЗМІШУВАННЯМ ЇХ ІЗ ҐРУНТОМ.....</b>	<b>76</b>
<i>ШВЕЦЬ Людмила Василівна, ШВЕЦЬ Олександр Ігорович</i> <b>РОЗРОБКА ТА ЕФЕКТИВНІСТЬ ВИКОРИСТАННЯ ГІДРАВЛІЧНОГО ПОДРІБНЮВАЧА ДЕРЕВИНИ ЯК ІНСТРУМЕНТУ ДЛЯ ПІДГОТОВКИ АЛЬТЕРНАТИВНОГО ПАЛИВА.....</b>	<b>84</b>

**III. ЕЛЕКТРОЕНЕРГЕТИКА, ЕЛЕКТРОТЕХНІКА ТА ЕЛЕКТРОМЕХАНІКА**

<i>ГРАНЯК Валерій Федорович, ТОКАРЧУК Олексій Анатолійович</i> <b>РОЗРОБКА КОНЦЕПЦІЇ РЕАЛІЗАЦІЇ МІКРОПРОЦЕСОРНОЇ СИСТЕМИ ВИМІРЮВАЛЬНОГО КОНТРОЮ ТЕМПЕРАТУРИ ТЕПЛИЧНИХ КОМПЛЕКСІВ.....</b>	<b>91</b>
--	-----------

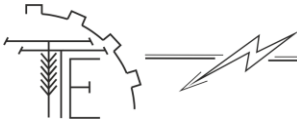

## CONTENTS

## I. APPLIED MECHANICS. MATERIALS SCIENCE. INDUSTRY MACHINERY BUILDING

<i>Yurii PALADIICHUK, Inna TELIATNYK, Maryna KUBAI</i> <b>METALLOGRAPHIC STUDY OF CHANGES IN THE STRUCTURE OF A DEFORMED METAL LAYER DURING WATER-PULSE SMOOTHING.....</b>	<b>7</b>
<i>Volodymyr PANASENKO, Dmytro DEINEKA</i> <b>PECULIARITIES OF DIETHYLAMINE DISTILLATION PROCESS FROM CALCIUM CHLORIDE AQUEOUS SOLUTION.....</b>	<b>23</b>
<i>Olena TRUKHANSKA, Maksym HADAICHUK</i> <b>ANALYSIS OF DESIGN AND TECHNOLOGICAL ASPECTS OF FUNCTIONING OF CHICORY ROOT DIGGERS.....</b>	<b>30</b>
<i>Andrii SHTUTS, Ihor BABYN, Pavlo LUTS</i> <b>STUDY OF STAMPING AND ROLLING PROCESSES IN THE FORMATION OF PIPELINE FLANGES.....</b>	<b>38</b>

## II. AGROENGINEERING

<i>Svetlana KRAVETS</i> <b>PROSPECTS FOR THE DEVELOPMENT OF HYDROGEN ENERGY: INNOVATIVE TECHNOLOGIES AS THE KEY TO REDUCING THE PRICE OF “GREEN” HYDROGEN...</b>	<b>46</b>
<i>Vadym RYABOSHAPKA</i> <b>COMPREHENSIVE STUDY OF THE FEASIBILITY CRITERIA FOR BIODIESEL PRODUCTION BASED ON FARMING ENTERPRISES.....</b>	<b>57</b>
<i>Olena TRUKHANSKA, Bohdan PERKHAILO</i> <b>TRENDS IN THE APPLICATION OF NEW TECHNOLOGIES AND MACHINES FOR HARVESTING BIOENERGY CROPS.....</b>	<b>70</b>
<i>Lyudmila SHVETS, Daryna PAVLYUK</i> <b>RESEARCH AND DEVELOPMENT OF UNIT FOR CUTTING BRANCHES WITH CROPPING AND MIXING THEM WITH SOIL.....</b>	<b>76</b>
<i>Lyudmila SHVETS, Oleksandr SHVETS</i> <b>DEVELOPMENT AND EFFICIENCY OF USING A HYDRAULIC WOOD CHIPPER AS A TOOL FOR THE PREPARATION OF ALTERNATIVE FUEL.....</b>	<b>84</b>

## III. ELECTRICAL ENERGY, ELECTRICAL ENGINEERING AND ELECTROMECHANICS

<i>Valerii HRANIAK, Oleksii TOKARCHUK</i> <b>DEVELOPMENT OF A CONCEPT FOR THE IMPLEMENTATION OF A MICROPROCESSOR SYSTEM FOR MEASURING THE TEMPERATURE OF GREENHOUSE COMPLEXES.....</b>	<b>91</b>
---	-----------

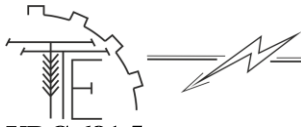
**DEVELOPMENT OF A CONCEPT FOR THE IMPLEMENTATION OF A MICROPROCESSOR SYSTEM FOR MEASURING THE TEMPERATURE OF GREENHOUSE COMPLEXES**

**Valerii HRANIAK**, Candidate of Technical Sciences, Associate Professor  
**Oleksii TOKARCHUK**, Candidate of Technical Sciences, Associate Professor  
Vinnytsia National Agrarian University

**ГРАНЯК Валерій Федорович**, к.т.н., доцент  
**ТОКАРЧУК Олексій Анатолійович**, к.т.н., доцент  
Вінницький національний аграрний університет

*Technological progress is characterized by the continuous expansion of automation across all areas of human activity, transitioning from partial automation to comprehensive automation, and then from comprehensive automation to full automation, which ensures the highest technical and economic efficiency.*

*This work develops a generalized concept for implementing a microprocessor-based temperature monitoring and control system for greenhouse complexes. It is characterized by high adaptability to the size and needs of greenhouse enterprises, as well as high flexibility in applying primary temperature measurement transducers from different types and manufacturers. The mentioned microprocessor system is designed for use as both a subsystem for automated climate control of a greenhouse complex and as a standalone system for monitoring the temperature distribution gradient within the greenhouse.*

*The architecture and a generalized prototype of the software for the temperature monitoring system in greenhouse complexes have been developed. This system can be used in the construction of climate control systems for greenhouse complexes. In each section of the greenhouse, the air temperature is controlled at 6 measurement points, and the soil temperature is monitored at 6 measurement points. The data from the sensors are processed according to several algorithms – for each sensor, for a group of sensors, autonomously by the microprocessor controller (with only alarm messages transmitted to the operator station), or by the operator station, with continuous transmission of real-time data from the microprocessor controller.*

*The system's modular design allows for easy scaling and integration with other greenhouse management technologies, making it suitable for various agricultural applications.*

**Key words:** *greenhouse complex, measurement, temperature, measurement control, microprocessor system, software.*

**F. 2. Fig. 4. Ref. 11.**

---

**1. Problem formulation**

---

The 21st century is often called the Information Age because the main achievements in technological progress are currently observed in the implementation of information technologies into various tools and automation systems [1]. Automation, however, is impossible without control and measurement equipment. Therefore, the development of control and measurement technology for automation systems is largely determined by advances in related fields of science and technology, such as microelectronics, computing technology, solid-state physics, and others [2].

Temperature measurement and control devices have long occupied a leading position in automated control systems for many processes. The increasing complexity of these processes leads to the need for a sharp rise in the number of measurement channels to ensure the necessary level of informational support. Thus, microprocessor-based subsystems for temperature control in winter greenhouse blocks are similar to complex industrial automation systems [3]. Considering that the temperature regime of greenhouses, as a microclimate parameter, directly affects the efficiency of plant growth [4], the development of a generalized approach suitable for building an automated temperature control system for such complexes is a relevant scientific and applied task.

Comprehensive control of the greenhouse microclimate (temperature, humidity, ventilation and heating modes, CO<sub>2</sub> concentration, etc.) allows greenhouse enterprises to significantly save resources and





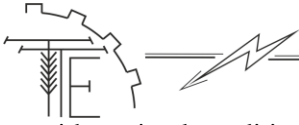

provide optimal conditions for plant growth and the activation of physiological processes in plants [5]. For this purpose, control and measurement equipment such as temperature, humidity, light, and pressure sensors is installed in different zones of the greenhouse, while a meteorological tower is typically set up outside the greenhouse.

The share of manual control in the technological systems of greenhouses, based on microclimate monitoring, is constantly and steadily decreasing [5, 6]. Automated greenhouse climate control systems (AGCCS) have become an integral part of modern greenhouse complexes [6, 7]. Different sizes and purposes of greenhouses require different levels of complexity and cost for their AGCCS.

Thus, the creation of a modern AGCCS that considers the diverse needs of greenhouse enterprises is a complex scientific and technical task, which can only be solved through the application of advanced information technologies, scientific theories of technical cybernetics, and modern industrial automation tools.

---

## 2. Analysis of recent research and publications

---

The design of the structure of a microprocessor-based system (MPS) for monitoring the temperature parameters of greenhouses, particularly winter greenhouses, should begin with an analysis of various options for organizing the internal channels for data input from sensors to the central microprocessor device (CPD).

Currently, there are many methods and tools for measuring temperature, as well as industrial devices based on them [3, 8]. To justify the selection of a measurement sensor for the new control subsystem, it is necessary to study these methods and tools, considering the following additional requirements:

- ease of implementation for electrical measurements, meaning the ease of obtaining electrical output signals for their input into the MPS;
- measurement range limited to the most common temperatures in greenhouse environments: from 0°C to +50°C;
- unified output signal;
- temperature measurement tools should provide high reliability, noise immunity, and have small dimensions, weight, and cost.

The output signals of most temperature sensor ICs currently available on the market are standardized for use in microprocessor and computer systems. Among these, analog, pulse, and digital output signals are the most widely used [9].

Digital signals are generated by sensors with a serial port that implements a special interface (e.g., SMBus or I2C). These sensors currently have the highest cost, which significantly increases the overall price of the MPS when used in large quantities.

Another type of signal that is well-suited for use in MPS is pulse signals (in the form of a square wave), where the frequency or period is proportional to the measured temperature. One of the typical representatives of this class of sensors is the MAX6577 from MAXIM [9], which is designed for an air temperature range from -40°C to +125°C. For this range, the frequency of the TTL-level output pulses varies from 0 to 8 kHz.

Processing pulse signals is performed using relatively simple software tools, and the cost of such sensors is an order of magnitude lower compared to digital ones. Therefore, in the following implementation example of the MPS, we will choose the MAX6577 temperature sensor chips from MAXIM, noting that if sensors of other types are used, the communication interface between the sensor and the numerical processing unit can be easily modified.

To input data from frequency-based temperature sensors to the CMD, the instantaneous value of the pulse frequency needs to be converted into a digital code. Two methods of this conversion have become the most widespread [1, 11]:

- by counting the periods of the measured frequency over a reference time interval;
- by counting the periods of a reference frequency over the period of the measured frequency.

Both of these methods have their advantages and disadvantages. The first method is very easy to implement, and the conversion result in the form of a digital code will be directly proportional to the measured frequency. The drawback of this method is the increase in measurement error as the measured frequency increases.

The second method of converting frequency to code involves some complexities when implemented in a microprocessor system because the resulting digital code is inversely proportional to the measured frequency. Therefore, to obtain the measurement result in the CMD, it is necessary to additionally provide for complex arithmetic operations. Moreover, this method is characterized by an increase in measurement error as the frequency of the measured signal decreases. All of this makes this method of converting the frequency of the temperature sensor signal into a code impractical for use in the designed MPS.

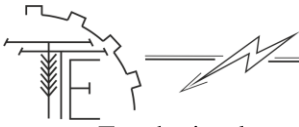

For the implementation of the first method of conversion, several approaches are known. One of the most widely used is realized with the help of digital counters, both for counting the periods of the measured frequency and for generating the reference time interval.

Figure 1 shows the structural electrical diagram of the designed MPS, which is built based on this principle.

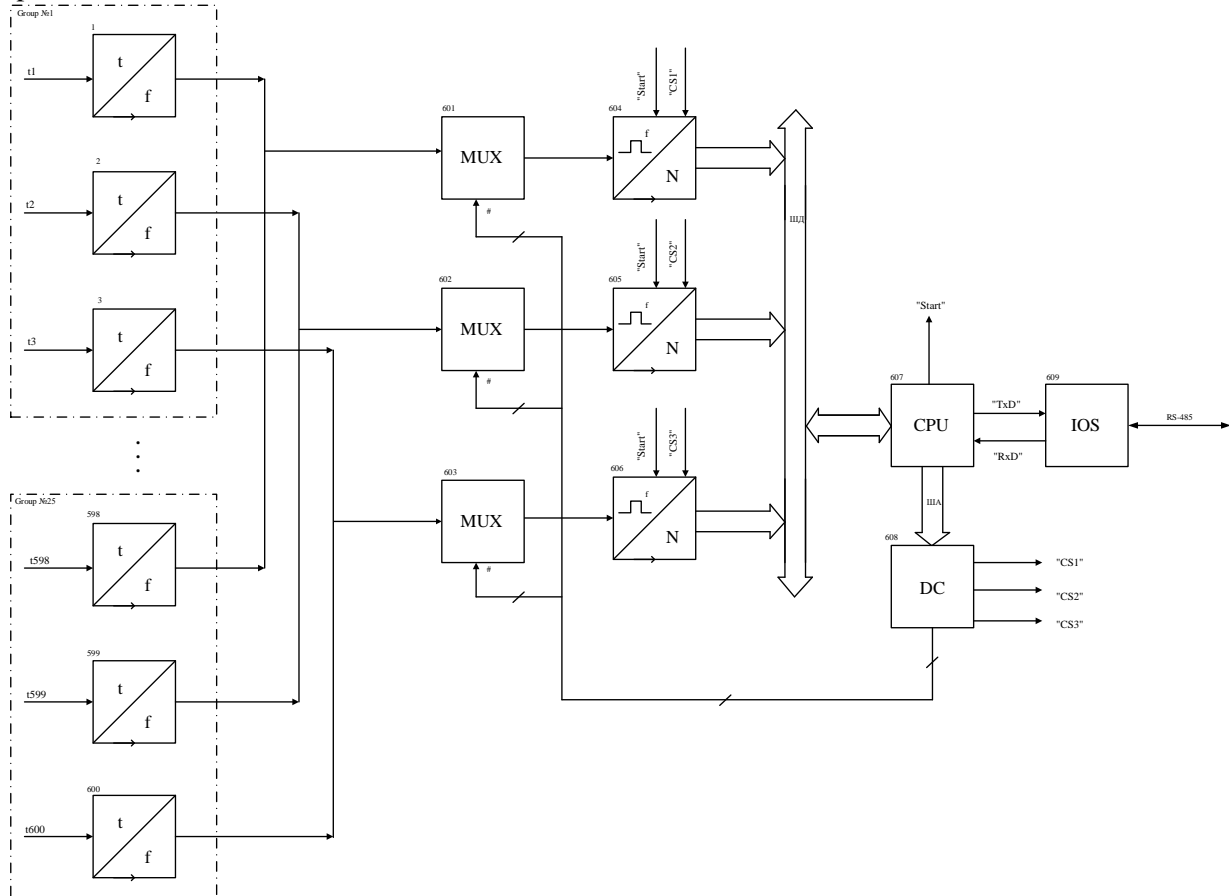

**Fig. 1** Electrical structural diagram of the designed microprocessor system

First, all temperature sensors are divided into groups, with three sensors in each group. This means that each group can measure the temperature in a local zone of the greenhouse section. Second, the sensor groups are combined into sections, with eight groups per section. This results in 25 sensor sections. Third, the addressing of the sensors is performed so that three sensors (i.e., one group) are connected simultaneously.

The structural diagram also includes frequency-to-code converters (604-606). To connect sensor groups (one of the 25 groups) to the circuit, three multiplexers (601-603) are used, which switch channels according to the addresses coming from the CPU address bus. Each of these multiplexers has 25 single-bit inputs, allowing all three sensors in a group to be connected simultaneously to their respective "frequency-to-code" converter. The conversion process begins with the "Start" signal. After the frequency codes are obtained (which are stored in the buffer registers of the converters), the codes are sequentially transferred to the CPU via the data bus under the control of the "CS1" – "CS3" device selection signals.

Additionally, a serial port (IOS 609) has been introduced into this scheme, designed for organizing data exchange between the MPS controller and the operator's ASUMT computer.

This organization of the MPS is quite economical in terms of the number of devices required for its implementation.

### 3. The purpose of the article

The purpose of the study is to develop and substantiate the concept of a microprocessor temperature control and monitoring system for greenhouse complexes, which ensures high adaptability to the size and needs of greenhouse enterprises, as well as flexibility in the use of primary temperature sensors of various types and manufacturers.



Research objectives: conduct an analysis of modern methods and means of temperature measurement, determining the most suitable for use in a microprocessor control system; develop the architecture of a microprocessor temperature monitoring system taking into account the requirements for adaptability and scalability for greenhouse complexes; create a structural electrical diagram of the system using frequency temperature sensors and justify the choice of signal type for their connection.

#### 4. Results of the researches

Figure 2 shows the developed diagram of the main program operation for the numerical converter of the microprocessor subsystem for control.

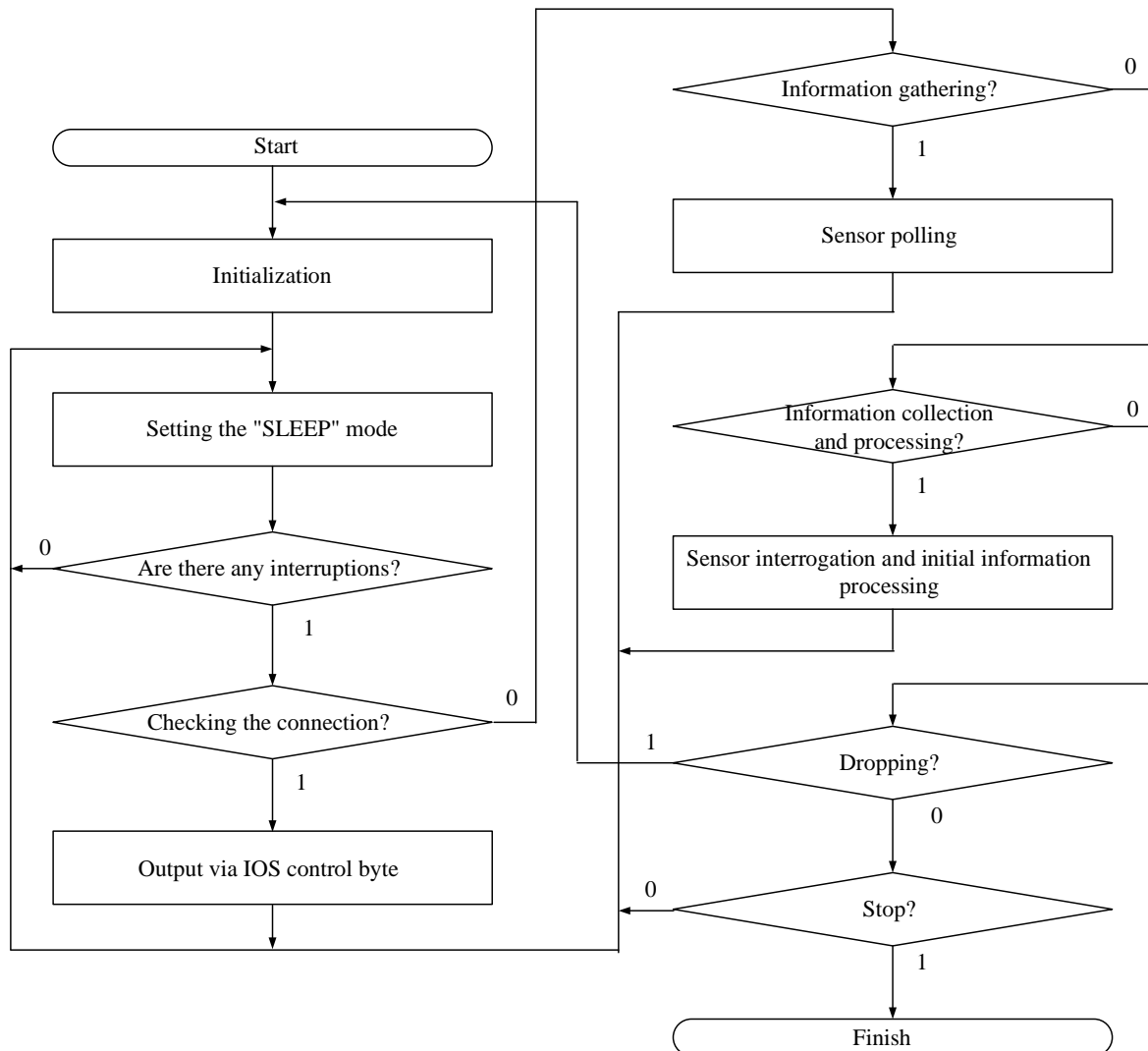
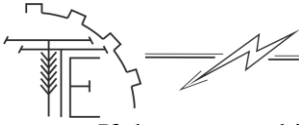

**Fig. 2 Block diagram of the main program of operation of the digital converter of the microprocessor control subsystem**

The operation of the microcomputer (micro-EOM) begins with the initialization procedure, during which the main variables and constants of the program are assigned, as well as the addresses of the MPS devices. Internal devices of the micro-EOM, such as the serial port and timers, as well as external devices – the "frequency-to-code" converters – are also initialized.

After completing all the operations of the initialization procedure, the micro-EOM transitions into a special low-power mode called "SLEEP." The micro-EOM will remain in this mode until it receives a data byte from the operator's PC through the serial port in the greenhouse climate control system.

The interrupt handling subroutine from the serial port is executed. This subroutine involves decoding the received byte, which is interpreted as a command. If the received command is to check the connection with the MPS, a control code (one byte) is sent through the serial port to the server.



If the command is to collect information from the temperature sensors, the subroutine for polling all the temperature sensors and transmitting the results through the serial port to the server is executed.

If the received command is for a more complex procedure of information collection, which involves preliminary processing of data from the sensors, the system performs a sequential collection of information from each sensor group (sensors from one section), calculates the average temperature value based on the data from these three sensors (the average temperature in the local area of the greenhouse section), and then transmits the average temperature value to the server.

If the received command is for a full reset of the MPS, the system transitions to the initialization procedure for the micro-EOM and all MPS devices.

Let's take a closer look at the algorithmic structure of individual subroutines in the main program.

Figure 3 shows the diagram of the subroutine for collecting information from the temperature sensors.

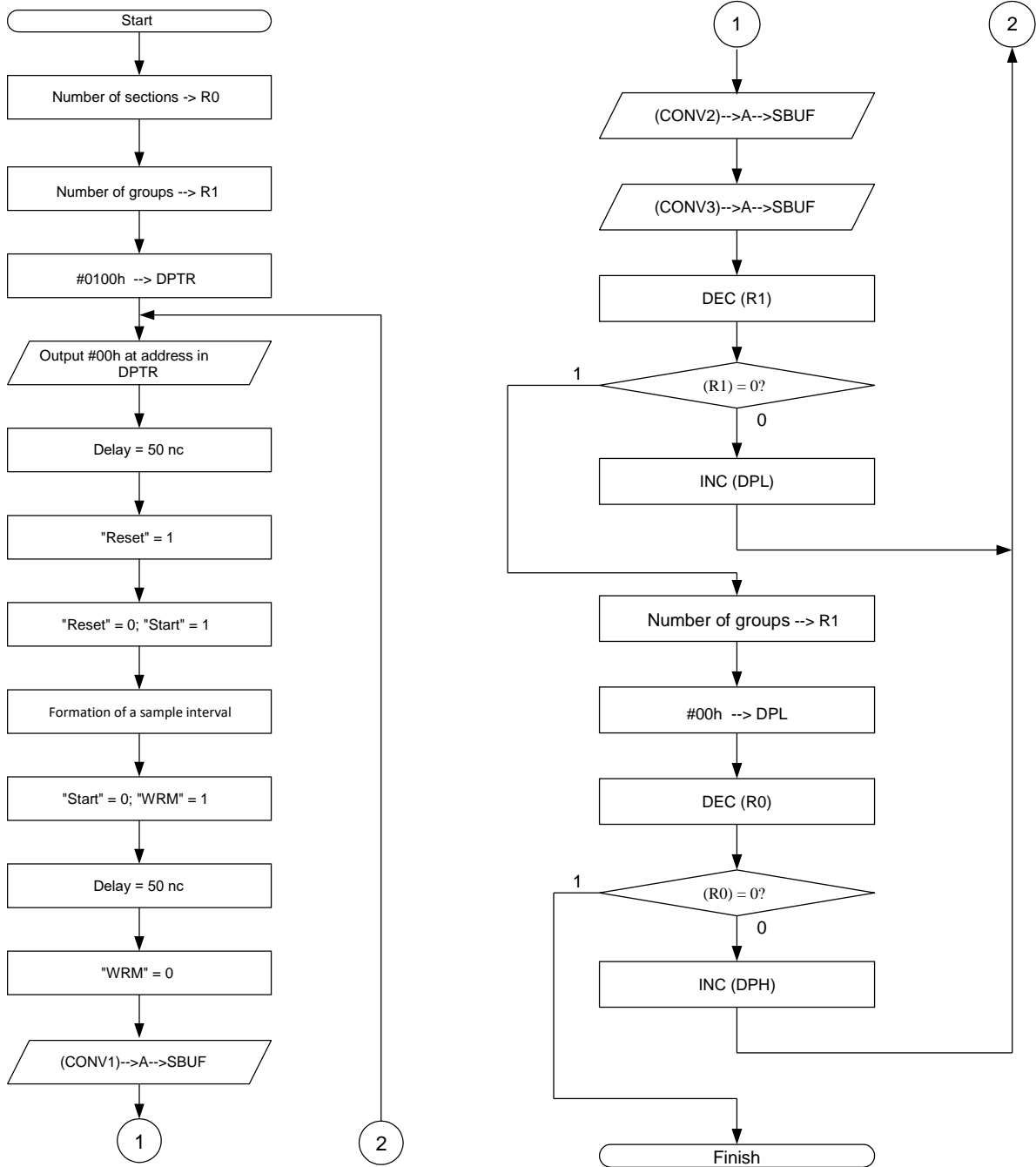

**Fig. 3** Flowchart of the subroutine for collecting information from temperature sensors

It represents a polling loop for all sensor sections and all sensor groups within these sections. The total number of sections is recorded in register R0 (value 19H). The total number of sensor groups in each section



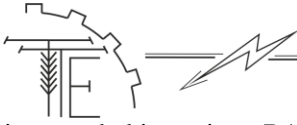

is recorded in register R1 (value 08H). The address 0100H of the first sensor group in the first section (address of the first channels of the first section of the multiplexers) is written to the DPTR register pair of the micro-EOM. A formal operation of writing the value 00H is performed at the established address. In this process, the address is written into two buffer address registers of the MPS. This is done to ensure reliable operation of the address decoders connected to these registers during all multiplexer switching and "frequency-to-code" conversion processes. After a time, delay of 50 ns, the counters of the "frequency-to-code" converters are reset by the "Reset" signal from the CPU. After that, the "Reset" signal is deactivated, and the "Start" signal is activated to begin the operation of these counters. The main subroutine of the measurement process is then executed – the subroutine for generating a reference time interval (referred to in the program text as "MEAS").

It begins with the subroutine TSO\_INIT, which allows preliminary setup of the micro-EOM's timer/counter operation mode for the selected method of measuring the frequency signal from the temperature sensors. Its description is provided below after the detailed development of the "MEAS" time interval generation subroutine, which controls the counters of the "frequency-to-code".

Let's calculate the main numerical characteristics of the reference time interval implemented by this subroutine.

The formation of the reference interval in the "MEAS" subroutine is performed by counting the number of periods of the reference frequency using the micro-EOM timer's counter.

There are several possible configurations of this counter, which differ in the number of its bits and the input reference frequency [11]. We choose a configuration where the number of bits in the timer's counter equals eight.

The input frequency of the temperature sensors ranges from 0 to 8 kHz for a temperature range from -40°C to +120°C. In our case, for the temperatures typical of winter greenhouse rooms, this temperature range can be significantly narrowed, for example, to a range of 0 °C to +50 °C. In this case, the frequency range of the sensor signals will be from 1.94 kHz to 4.364 kHz. It is these signals that are counted by the counters of the three "frequency-to-code" converters during the reference time interval formed by the "MEAS" subroutine. These counters also have eight bits of output code.

Thus, the maximum value of this code  $N_{\max}$  at the maximum frequency  $f_{\max}$  of the temperature sensor for the selected range with a reference time interval  $\Delta T$  (which equals the overflow time of the timer counter with the reference frequency  $f_0$ , i.e., the time it takes to pass 256 periods of the reference frequency) is:

$$N_{\max} = f_{\max} \cdot \Delta T = \frac{256 \cdot f_{\max}}{f_0}. \quad (1)$$

For an 8-bit frequency-code converter counter, this maximum output code value can be equal to 255. Then the required sample frequency for the timer counter will be:

$$f_0 = \frac{256 \cdot f_{\max}}{255} \approx f_{\max}. \quad (2)$$

Thus, for the implementation of the program for generating a reference time interval, a 4.364 kHz reference frequency generator needs to be implemented programmatically.

The reference frequency is implemented by configuring the operation mode of timer/counter T0. This counter in mode 3 is divided into two parts: the lower part TL0 (eight bits) and the upper part TH0 (eight bits). The upper part receives pulses from the microprocessor's clock generator (12 MHz), which are divided by 12. This means the pulse counting frequency is 1 MHz. When the counter overflows, the flag TF1 is set. Thus, the overflow time of the TH0 counter is 256  $\mu$ s. However, the required reference time interval  $\Delta T$  is  $256/4364 = 0.05866$  s = 58.66 ms = 58660  $\mu$ s. Therefore, one overflow of the TH0 counter is not enough to form the reference time interval. The necessary number of overflows is  $58660/256 = 229$ . In binary, this number of overflows is E5H.

Before the "MEAS" subroutine, the "TCO\_INIT" subroutine for initializing the timer/counter T/C0 is executed, which works in mode 3 (both timer/counter registers are cleared). In the "MEAS" subroutine, an additional register R5 is used, where the number of overflows of the TH0 timer is accumulated. The moment of overflow is recorded when the TF1 flag is set. After 229 overflows, corresponding to the required reference time interval, the TH0 counter is stopped with the TR1 bit. The measurement result (the number of pulses from the sensor during the reference time interval) is stored in the counters of the corresponding "frequency-to-code" converter.

After the formation of the reference time interval is completed, the "Start" signal is reset. A "WRM" signal is issued, causing the contents of the counters to be written into the corresponding buffer registers. The

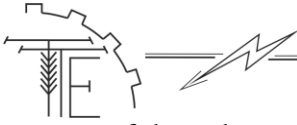

contents of these three registers are then sequentially entered into the microcomputer and transmitted to the operator's computer.

The address of the next sensor group is modified. The conditions for matching the specified number of sections and the number of groups within those sections are checked. If these conditions are met, the data collection process is repeated for the next sensor group. If the addresses exceed the set boundaries, it means all sensors have been polled. The subroutine ends, and the microcomputer returns to the "SLEEP" mode.

Appendix J shows the diagram of the subroutine for collecting and performing initial processing of the data from the sensors. It differs from the previous one in that, when entering codes from the converters, they are not transmitted to the central computer, but are stored in the R2, R3, R4 registers of the microcomputer. After they are entered into the microcomputer, their average value is calculated, and this value is then transmitted to the operator's computer.

The software architecture will consist of two forms: the execution form (task form) and the graphical form (display form).

The execution form will be responsible for the hardware reception of data from the MPC controller, their preliminary processing and analysis, as well as data transmission for display to the operator.

The graphical form (display form) will be responsible for the graphical representation of information to the operator in the form of temperature indicators in each greenhouse section of the complex. For example, in one greenhouse section (in six points – air temperature and in six points – soil temperature). This form will also be used to input commands from the operator for controlling the MPC controller.

The execution form can be conveniently organized as two separate tasks ("TASK1" and "TASK2"). The "TASK1" task will perform hardware data reception from the MPC controller via the computer's COM1 serial port, carry out preliminary processing and analysis based on the nature of the data for each section, and also send commands through the COM1 serial port to the MPC controller.

The "TASK2" task will perform secondary processing of data from all the temperature sensors in the control system, i.e., analyzing the signal from each sensor in each section of the greenhouse and transmitting the results of the analysis to the graphical display form.

The results of data processing from the execution forms "TASK1" and "TASK2" will be output to the graphical form, that is, to the operator's interface.

This graphical form will represent the main screen "DISP1" – the main operator interface screen, through which the operator will provide commands to the MPC controller and receive overall information about the temperature status in the greenhouse blocks.

Figure 4 shows the external appearance of the designed main screen "DISP1" in the SCADA system Genie display form editor.

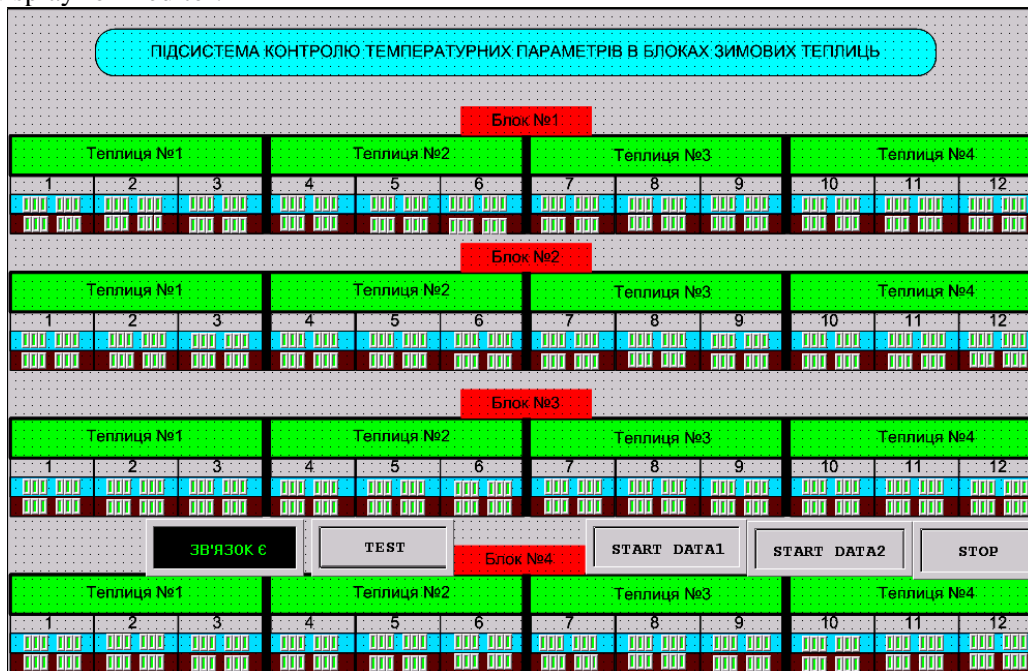
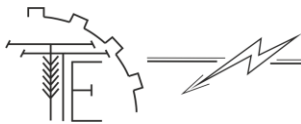

Fig. 4 Main screen appearance "DISP1"



The screen displays simplified images of 16 greenhouses grouped into 4 blocks. Each greenhouse is divided into three sections, where the air temperature (6 sensors on a blue background) and the soil temperature (6 sensors on a brown background) are measured.

To display the statuses of these sensors, a "Color Indicator" type display form is used. There are 574 such indicators (24 spare sensors are not shown), meaning each indicator represents the temperature status at a specific control point in the section: green indicates normal temperature (within set limits), blue indicates the temperature is below the minimum set threshold, and red indicates the temperature exceeds the maximum set threshold. The indicators are linked to the corresponding algorithmic blocks in the execution form "TASK1," specifically blocks "T1.1" – "T100.6."

At the bottom of the main screen, there are also display forms in the form of four virtual buttons: "TEST," "START DATA1," "START DATA2," and "STOP," through which the operator inputs commands to the MPC controller as described above. To the left of the "TEST" button is a graphical indicator of the "Text Output by Condition" type, which is linked to the algorithmic block "LINK ALARM" of the "TASK1" execution form. If the connection between the controller and the PC is working properly, the message "Connection is established" will be displayed in green letters. Otherwise, the message "No connection" will appear in red letters with flashing text.

---

## 5. Conclusions.

---

As a result of the research, a generalized concept of a microprocessor temperature measurement system for greenhouse complexes was created, which is based on the principles of adaptability and flexibility. This allows you to effectively adapt the system to different sizes of greenhouses and use temperature sensors of different types and manufacturers. This approach increases the versatility and functionality of the developed system.

The developed architecture of the system and the created test prototype of the software demonstrate the possibility of effective integration into modern climate control systems. The implementation of these solutions ensures accurate monitoring of temperature both in the air and in the soil, contributing to the improvement of the microclimate management of greenhouses.

Prototype testing confirmed the system's ability to process large volumes of data with high accuracy and reliability. The use of the developed system allows you to automate temperature control processes, which reduces energy costs, reduces manual labor and creates optimal conditions for plant growth and development.

The system provides scalability and can be used in greenhouses of various sizes. This allows meeting the needs of both small and large agricultural enterprises, ensuring the efficiency and economic feasibility of its implementation.

Thus, the developed microprocessor system for temperature monitoring and control is an actual and scientifically based solution for improving climate control in greenhouse complexes.

## References

1. Shambhavi, R., Clinton, D., & Manish, A. (2023). *Fundamentals of Information Technology*. Tampa; University of South Florida. [in English].
2. Yermieiev, I. S., & Kyselov, V. B. (2022). *Avtomatyzovani systemy upravlinnia tekhnolohichnymy protsesamy [Automated control systems of technological processes]*. Zaporizhzhia: Helvetica [in Ukrainian].
3. Aloui, F., Varuvel, E. G., & Sonthalia, A. (2023). *Handbook of Thermal Management Systems*. Elsevier. [in English].
4. Villalobos, F. J., & Fereres, E. (2024). *Principles of Agronomy for Sustainable Agriculture*. Springer [in English].
5. Mefferd, A. (2017). *The Greenhouse and Hoophouse Grower's Handbook*. Chelsea: Chelsea Green Publishing. [in English].
6. Osorio-Luna, D.F., & Molina-Ruiz, P.A. (2019). Automation and control of greenhouse implemented technologies: a review. *Visión Electrónica*, 2 (2), 381–394 [in English].
7. Sharapa, O.V., & Berdnikov, A.G. (2020). Model of process control system in greenhouse agro-industrial complex. *Bulletin of V.N. Karazin Kharkiv National University, Series «Mathematical Modeling. Information Technology. Automated Control Systems»*, 47, 86–92. [in English].
8. Liptak, B.G. (2022). *Temperature Measurement*. Boca Raton: CRC Press. [in English].
9. Pertijs, M.A.P. (2006). *Precision Temperature Sensors in CMOS Technology*. Springer. [in English].
10. Raghavendra, N.V., & Krishnamurthy, L. (2013). *Engineering metrology and measurements*. Oxford:

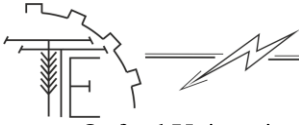

Oxford University Press [in English].

11. Goossens, G. (2023) *Guide to Computer Processor Architecture: A RISC-V Approach, with High-Level Synthesis*. Springer [in English].

### РОЗРОБКА КОНЦЕПЦІЇ РЕАЛІЗАЦІЇ МІКРОПРОЦЕСОРНОЇ СИСТЕМИ ВИМІРЮВАЛЬНОГО КОНТРОЛЮ ТЕМПЕРАТУРИ ТЕПЛИЧНИХ КОМПЛЕКСІВ

*Технічний прогрес характеризується безупинним розширенням автоматизації усіх галузей діяльності людини, переходом від часткової автоматизації до комплексної, а потім від комплексної автоматизації до повної, яка забезпечує найвищу техніко-економічну ефективність.*

*В роботі розроблено узагальнену концепцію реалізації мікропроцесорної системи вимірювального контролю температури тепличних комплексів, що характеризується високою адаптивністю до розмірів та потреб тепличного господарства та високою гнучкістю до застосування первинних вимірювальних перетворювачів температури різних типів та виробників. Зазначена мікропроцесорна система призначена для використання в якості як підсистеми автоматизованого управління мікрокліматом тепличного комплексу так і окремої системи моніторингу градієнту розподілу температури у межах тепличного господарства.*

*Розроблено архітектуру та тестовий узагальнений прототип програмного забезпечення системи вимірювального контролю температури тепличних комплексів, що може бути використаний при побудові системи клімат-контролю тепличних комплексів. При цьому в кожному відділенні теплиці контролюється температура повітря в 6 контрольних точках та температура ґрунту в 6 контрольних точках. Оброблення інформації з датчиків виконується за кількома алгоритмами – по кожному датчику, по групі датчиків, автономно контролером МПС (з передаванням на операторську станцію тільки тривожних повідомлень) або операторською станцією при постійному передаванні поточних даних з контролера МПС.*

*Модульна конструкція системи дозволяє легко масштабувати та інтегрувати її з іншими технологіями управління теплицями, що робить її придатною для різноманітних сільськогосподарських застосувань.*

**Ключові слова:** тепличний комплекс, вимірювання, температура, вимірювальний контроль, мікропроцесорна система, програмне забезпечення.

**Ф. 2 Рис.4. Літ. 11.**

#### INFORMATION ABOUT THE AUTHORS

**Valerii HRANIYAK** – Candidate of Technical Sciences, Associate Professor, Associate Professor of the Department of Power engineering, electrical engineering and electromechanics of Vinnytsia National Agrarian University. (3 Soniachna St., Vinnytsia, Ukraine, 21008, e-mail: titanxp2000@ukr.net <https://orcid.org/0000-0001-6604-6157>).

**Oleksii TOKARCHUK** – Candidate of Technical Sciences, Associate Professor, head of the Department of Engineering Mechanics and Technological Processes at the Agricultural Complex of the Vinnytsia National Agrarian University (3, Solnyshchaya St., Vinnytsia, 21008, Ukraine, e-mail: tokarchyk08@ukr.net, <https://orcid.org/0000-0001-8036-1743>).

**ГРАНЯК Валерій Федорович** – кандидат технічних наук, доцент, завідувач кафедри «Електротехніки, електроенергетики та електромеханіки» Вінницького національного аграрного університету (вул. Сонячна, 3, м. Вінниця, Україна, 21008, e-mail: titanxp2000@ukr.net, <https://orcid.org/0000-0001-6604-6157>).

**ТОКАРЧУК Олексій Анатолійович** – кандидат технічних наук, доцент, завідувач кафедри Інженерної механіки та технологічних процесів в АПК Вінницького національного аграрного університету (вул. Сонячна, 3, м. Вінниця, 21008, Україна, e-mail: tokarchyk08@ukr.net, <https://orcid.org/0000-0001-8036-1743>).